

# DENON

## AV SURROUND RECEIVER

# AVR-791

---

Owner's Manual

Manuel de l'Utilisateur

Manual del usuario

**Simple  
version**

Version simplifiée  
Versión sencilla



**Basic  
version**

Version basique  
Versión básica



**Advanced  
version**



Version avancée  
Versión avanzada



**Information**

"Part names and functions"  
( page 65)



**Informations**  
"Nomenclature et fonctions"  
( page 65)  
**Información**  
"Nombres y funciones de las  
piezas" ( página 65)

SAFETY PRECAUTIONS

**CAUTION**  
**RISK OF ELECTRIC SHOCK**  
**DO NOT OPEN**

**CAUTION:**  
**TO REDUCE THE RISK OF ELECTRIC SHOCK, DO NOT REMOVE COVER (OR BACK). NO USER-SERVICEABLE PARTS INSIDE. REFER SERVICING TO QUALIFIED SERVICE PERSONNEL.**

The lightning flash with arrowhead symbol, within an equilateral triangle, is intended to alert the user to the presence of uninsulated "dangerous voltage" within the product's enclosure that may be of sufficient magnitude to constitute a risk of electric shock to persons.

The exclamation point within an equilateral triangle is intended to alert the user to the presence of important operating and maintenance (servicing) instructions in the literature accompanying the appliance.

**WARNING:**  
**TO REDUCE THE RISK OF FIRE OR ELECTRIC SHOCK, DO NOT EXPOSE THIS APPLIANCE TO RAIN OR MOISTURE.**

Hot surface mark

**CAUTION:**  
**HOT SURFACE. DO NOT TOUCH.**

The top surface over the internal heat sink may become hot when operating this product continuously. Do not touch hot areas, especially around the "Hot surface mark" and the top panel.

**PRECAUTION:**  
**SURFACE CHAUDE. NE PAS TOUCHER.**

La surface supérieure du dissipateur de chaleur peut devenir chaude si vous utilisez ce produit en continu. Ne touchez pas les zones chaudes, tout particulièrement vers l'inscription "Hot surface mark" et le panneau supérieur.

**PRECAUCIÓN:**  
**SUPERFICIE CALIENTE. NO TOCAR.**

La superficie superior sobre el disipador de calor interno podría llegar a calentarse al operar este producto de forma continua. No toque las áreas calientes, especialmente las situadas alrededor de la "Hot surface mark" y del panel superior.

# IMPORTANT SAFETY INSTRUCTIONS

1. Read these instructions.
2. Keep these instructions.
3. Heed all warnings.
4. Follow all instructions.
5. Do not use this apparatus near water.
6. Clean only with dry cloth.
7. Do not block any ventilation openings. Install in accordance with the manufacturer's instructions.
8. Do not install near any heat sources such as radiators, heat registers, stoves, or other apparatus (including amplifiers) that produce heat.
9. Do not defeat the safety purpose of the polarized or grounding-type plug. A polarized plug has two blades with one wider than the other. A grounding type plug has two blades and a third grounding prong. The wide blade or the third prong are provided for your safety. If the provided plug does not fit into your outlet, consult an electrician for replacement of the obsolete outlet.
10. Protect the power cord from being walked on or pinched particularly at plugs, convenience receptacles, and the point where they exit from the apparatus.
11. Only use attachments/accessories specified by the manufacturer.
12. Use only with the cart, stand, tripod, bracket, or table specified by the manufacturer, or sold with the apparatus. When a cart is used, use caution when moving the cart/apparatus combination to avoid injury from tip-over.
13. Unplug this apparatus during lightning storms or when unused for long periods of time.
14. Refer all servicing to qualified service personnel. Servicing is required when the apparatus has been damaged in any way, such as power-supply cord or plug is damaged, liquid has been spilled or objects have fallen into the apparatus, the apparatus has been exposed to rain or moisture, does not operate normally, or has been dropped.
15. Batteries shall not be exposed to excessive heat such as sunshine, fire or the like.



**CAUTION:**

To completely disconnect this product from the mains, disconnect the plug from the wall socket outlet. The mains plug is used to completely interrupt the power supply to the unit and must be within easy access by the user.

**PRECAUTION:**

Pour déconnecter complètement ce produit du courant secteur, débranchez la prise de la prise murale. La prise secteur est utilisée pour couper complètement l'alimentation de l'appareil et l'utilisateur doit pouvoir y accéder facilement.

**PRECAUCIÓN:**

Para desconectar completamente este producto de la alimentación eléctrica, desconecte el enchufe del enchufe de la pared. El enchufe de la alimentación eléctrica se utiliza para interrumpir por completo el suministro de alimentación eléctrica a la unidad y debe de encontrarse en un lugar al que el usuario tenga fácil acceso.

**FCC INFORMATION (For US customers)**

**1. PRODUCT**

This product complies with Part 15 of the FCC Rules. Operation is subject to the following two conditions: (1) this product may not cause harmful interference, and (2) this product must accept any interference received, including interference that may cause undesired operation.

**2. IMPORTANT NOTICE: DO NOT MODIFY THIS PRODUCT**

This product, when installed as indicated in the instructions contained in this manual, meets FCC requirements. Modification not expressly approved by DENON may void your authority, granted by the FCC, to use the product.

**3. NOTE**

This product has been tested and found to comply with the limits for a Class B digital device, pursuant to Part 15 of the FCC Rules. These limits are designed to provide reasonable protection against harmful interference in a residential installation. This product generates, uses and can radiate radio frequency energy and, if not installed and used in accordance with the instructions, may cause harmful interference to radio communications. However, there is no guarantee that interference will not occur in a particular installation. If this product does cause harmful interference to radio or television reception, which can be determined by turning the product OFF and ON, the user is encouraged to try to correct the interference by one or more of the following measures:

- Reorient or relocate the receiving antenna.
- Increase the separation between the equipment and receiver.
- Connect the product into an outlet on a circuit different from that to which the receiver is connected.
- Consult the local retailer authorized to distribute this type of product or an experienced radio/TV technician for help.

**For Canadian customers:**  
 This Class B digital apparatus complies with Canadian ICES-003.  
 Cet appareil numérique de la classe B est conforme à la norme NMB-003 du Canada.

☐ NOTES ON USE / OBSERVATIONS RELATIVES A L'UTILISATION / NOTAS SOBRE EL USO

WARNINGS	AVERTISSEMENTS	ADVERTENCIAS
<ul style="list-style-type: none"> <li>• Avoid high temperatures. Allow for sufficient heat dispersion when installed in a rack.</li> <li>• Handle the power cord carefully. Hold the plug when unplugging the cord.</li> <li>• Keep the unit free from moisture, water, and dust.</li> <li>• Unplug the power cord when not using the unit for long periods of time.</li> <li>• Do not obstruct the ventilation holes.</li> <li>• Do not let foreign objects into the unit.</li> <li>• Do not let insecticides, benzene, and thinner come in contact with the unit.</li> <li>• Never disassemble or modify the unit in any way.</li> <li>• Ventilation should not be impeded by covering the ventilation openings with items, such as newspapers, tablecloths or curtains.</li> <li>• Naked flame sources such as lighted candles should not be placed on the unit.</li> <li>• Observe and follow local regulations regarding battery disposal.</li> <li>• Do not expose the unit to dripping or splashing fluids.</li> <li>• Do not place objects filled with liquids, such as vases, on the unit.</li> <li>• Do not handle the mains cord with wet hands.</li> <li>• When the switch is in the OFF position, the equipment is not completely switched off from MAINS.</li> <li>• The equipment shall be installed near the power supply so that the power supply is easily accessible.</li> </ul>	<ul style="list-style-type: none"> <li>• Eviter des températures élevées. Tenir compte d'une dispersion de chaleur suffisante lors de l'installation sur une étagère.</li> <li>• Manipuler le cordon d'alimentation avec précaution. Tenir la prise lors du débranchement du cordon.</li> <li>• Protéger l'appareil contre l'humidité, l'eau et la poussière.</li> <li>• Débrancher le cordon d'alimentation lorsque l'appareil n'est pas utilisé pendant de longues périodes.</li> <li>• Ne pas obstruer les trous d'aération.</li> <li>• Ne pas laisser des objets étrangers dans l'appareil.</li> <li>• Ne pas mettre en contact des insecticides, du benzène et un diluant avec l'appareil.</li> <li>• Ne jamais démonter ou modifier l'appareil d'une manière ou d'une autre.</li> <li>• Ne pas recouvrir les orifices de ventilation avec des objets tels que des journaux, nappes ou rideaux. Cela entraverait la ventilation.</li> <li>• Ne jamais placer de flamme nue sur l'appareil, notamment des bougies allumées.</li> <li>• Veillez à respecter les lois en vigueur lorsque vous jetez les piles usagées.</li> <li>• L'appareil ne doit pas être exposé à l'eau ou à l'humidité.</li> <li>• Ne pas poser d'objet contenant du liquide, par exemple un vase, sur l'appareil.</li> <li>• Ne pas manipuler le cordon d'alimentation avec les mains mouillées.</li> <li>• Lorsque l'interrupteur est sur la position OFF, l'appareil n'est pas complètement déconnecté du SECTEUR (MAINS).</li> <li>• L'appareil sera installé près de la source d'alimentation, de sorte que cette dernière soit facilement accessible.</li> </ul>	<ul style="list-style-type: none"> <li>• Evite altas temperaturas. Permite la suficiente dispersión del calor cuando está instalado en la consola.</li> <li>• Maneje el cordón de energía con cuidado. Sostenga el enchufe cuando desconecte el cordón de energía.</li> <li>• Mantenga el equipo libre de humedad, agua y polvo.</li> <li>• Desconecte el cordón de energía cuando no utilice el equipo por mucho tiempo.</li> <li>• No obstruya los orificios de ventilación.</li> <li>• No deje objetos extraños dentro del equipo.</li> <li>• No permita el contacto de insecticidas, gasolina y diluyentes con el equipo.</li> <li>• Nunca desarme o modifique el equipo de ninguna manera.</li> <li>• La ventilación no debe quedar obstruida por haberse cubierto las aperturas con objetos como periódicos, manteles o cortinas.</li> <li>• No deberán colocarse sobre el aparato fuentes inflamables sin protección, como velas encendidas.</li> <li>• A la hora de deshacerse de las pilas, respete la normativa para el cuidado del medio ambiente.</li> <li>• No exponer el aparato al goteo o salpicaduras cuando se utilice.</li> <li>• No colocar sobre el aparato objetos llenos de líquido, como jarros.</li> <li>• No maneje el cable de alimentación con las manos mojadas.</li> <li>• Cuando el interruptor está en la posición OFF, el equipo no está completamente desconectado de la alimentación MAINS.</li> <li>• El equipo se instalará cerca de la fuente de alimentación de manera que resulte fácil acceder a ella.</li> </ul>

☐ CAUTIONS ON INSTALLATION  
PRÉCAUTIONS D'INSTALLATION  
EMPLAZAMIENTO DE LA INSTALACIÓN

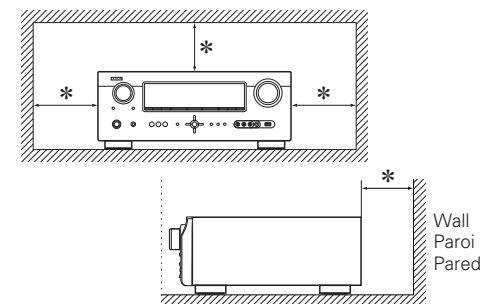

**\* For proper heat dispersal, do not install this unit in a confined space, such as a bookcase or similar enclosure.**

- More than 0.3 m (12 in.) is recommended.
- Do not place any other equipment on this unit.

**\* Pour permettre la dissipation de chaleur requise, n'installez pas cette unité dans un espace confiné tel qu'une bibliothèque ou un endroit similaire.**

- Une distance de plus de 0,3 m (12 po) est recommandée.
- Ne placez aucun matériel sur cet appareil.

**\* Para la dispersión del calor adecuadamente, no instale este equipo en un lugar confinado tal como una librería o unidad similar.**

- Se recomienda dejar más de 0.3 m (12 pulg.) alrededor.
- No coloque ningún otro equipo sobre la unidad.

# Getting started

Thank you for purchasing this DENON product. To ensure proper operation, please read these owner's manual carefully before using the product. After reading them, be sure to keep them for future reference.

## Contents

**Getting started** ..... 1  
 Accessories ..... 1  
 About this manual ..... 1  
 Features ..... 2  
 Cautions on handling ..... 2

## Simple version (Simple setup guide) ..... 3

## Basic version ..... 12

**Connections** ..... 13  
 Important information ..... 13  
 Connecting an HDMI-compatible device ..... 14  
 Connecting a TV ..... 16  
 Connecting a Blu-ray Disc player / DVD player ..... 16  
 Connecting a set-top box (Satellite tuner/cable TV) ..... 17  
 Connecting a digital camcorder ..... 17  
 Connecting a control dock for iPod ..... 18  
 Connecting an iPod or USB memory device to the USB Port ..... 18  
 Connecting a CD player ..... 19  
 Connecting an antenna ..... 19  
**Playback (Basic operation)** ..... 20  
 Important information ..... 20  
 Playing a Blu-ray Disc player/DVD player ..... 21  
 Playing a CD player ..... 21  
 Playing an iPod® ..... 21  
 Tuning in radio stations ..... 24  
 Playing a USB memory device ..... 25  
**Selecting a listening mode (Surround mode)** ..... 26  
 Standard playback ..... 26  
 DENON original surround playback ..... 28  
 Stereo playback ..... 28  
 Direct playback ..... 28  
 Pure direct playback ..... 28

## Advanced version ..... 29

**Speaker installation/connection (Other than 5.1-channel)** ..... 30  
 Install ..... 30  
 Connect ..... 31  
 Set up speakers ..... 33  
**Playback (Advanced operation)** ..... 34  
 Convenient functions ..... 34  
**Playback in ZONE2 (Separate room)** ..... 37  
 Audio output ..... 37  
 Playback ..... 37  
 Quick select function ..... 38  
**How to make detailed settings** ..... 39  
 Menu map ..... 39  
 Examples of on-screen display and front display ..... 40  
 Inputting characters ..... 41  
 Input Setup ..... 42  
 Audio Adjust ..... 47  
 Manual Setup ..... 52  
 Information ..... 59  
**Operating the connected devices by remote control unit** ..... 60  
 Operating AV equipment ..... 60  
 Registering preset codes ..... 60  
 Operating components ..... 62  
 Specifying the zone used with the remote control unit ..... 63  
 Resetting the remote control unit ..... 63

## Information ..... 64

**Part names and functions** ..... 65  
 Front panel ..... 65  
 Display ..... 65  
 Rear panel ..... 66  
 Remote control unit ..... 67  
**Other information** ..... 69  
 Trademark information ..... 69  
 Surround ..... 70  
 Explanation of terms ..... 74  
**Troubleshooting** ..... 76  
 Resetting the microprocessor ..... 78  
**Specifications** ..... 78

## Accessories

Check that the following parts are supplied with the product.

① Owner's manual ..... 1  
 ② Warranty (for North America model only) ..... 1  
 ③ Service network list ..... 1  
 ④ Remote control unit (RC-1146) ..... 1  
 ⑤ R6/AA batteries ..... 2  
 ⑥ Setup microphone (DM-A409, Cord length: Approx. 25 ft / 7.6 m) ..... 1  
 ⑦ AM loop antenna ..... 1  
 ⑧ FM indoor antenna ..... 1

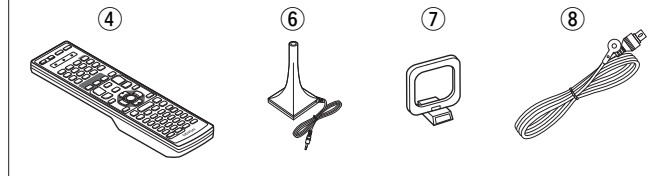

## About this manual

### ❑ Operation buttons

The operations described in this manual are based mainly on use of the remote control unit buttons.

### ❑ Symbols



This symbol indicates a reference page on which related information is described.



This symbol indicates a supplementary information and tips for operations.

**NOTE**

This symbol indicates points to remember operations or function limitations.

### ❑ Illustrations

Note that the illustrations in these instructions may differ from the actual unit for explanation purposes.

## Features

### Fully Discrete, identical quality and power for all 7 channels (125 W x 7ch)

The unit is equipped with a power amplifier that plays back high-fidelity sound in surround mode with equal quality and power for all channels, true to the original sound.

The power amplifier circuit adopts a discrete-circuit configuration that achieves high-quality surround sound play back.

### Supports HDMI 1.4 with 3D, ARC, Deep Color, "x.v.Color" , Auto Lipsync and HDMI control function

This unit can output 3D video signals input from a Blu-ray Disc player to a TV that supports a 3D system. This unit also supports the ARC (Audio Return Channel) function, which plays back TV sound with this unit via an HDMI cable used for connecting the unit and a TV\*.

\* The TV should support the ARC function.

### 4-HDMI inputs and 1-output

The unit is equipped with 4 HDMI input connectors for connecting devices with HDMI connectors, such as a Blu-ray Disc player, game machine, HD video camera, etc.

### High Definition Audio Support

The unit is equipped with a decoder which supports high-quality digital audio format for Blu-ray Disc players such as Dolby TrueHD, DTS-HD Master Audio, etc.

### Dolby Pro LogicIIz

The unit is provided with a Dolby Pro LogicIIz decoder. When you play back the sound in Dolby Pro LogicIIz playback with front height speakers connected to the unit, you can enjoy playback sound with rich spacial expression.

### Easy to use, On Screen Display

Simple settings are enabled with the setting menus displayed on the TV screen. When you control the sound volume, the volume level is displayed on the screen, and when you switch the input source, the name of the input source is displayed.

### Auto setup function

The unit is provided with an "Auto setup function" which automatically makes speaker settings best suited for the listening environment. The sound from the speakers is picked up with the supplied microphone. Reflecting sound and audio characteristics of speakers are measured, and settings for an optimum sound field are automatically made.

### All Sources are Up-Scaled to 1080p

The unit is provided with an HDMI video upscaling function that converts an analog video signal input to the unit to a 1080p (HD resolution) signal and supplies it to a TV via the HDMI connector. This enables the unit and a TV connected with a single HDMI cable and any video source to be reproduced precisely with HD level of quality.

### Direct Play for iPod® and iPhone® via USB

Music data from an iPod can be played back if you connect the USB cable supplied with the iPod via the USB port of this unit, and also an iPod can be controlled with the remote control unit for this unit.

When an iPod is connected, merely pressing **iPod PLAY** on the main unit or remote control unit starts playback of music from the iPod.

## Cautions on handling

### • Before turning the power switch on

Check once again that all connections are correct and that there are no problems with the connection cables.

- Power is supplied to some of the circuitry even when the unit is set to the standby mode. When traveling or leaving home for long periods of time, be sure to unplug the power cord from the power outlet.

### • About Condensation

If there is a major difference in temperature between the inside of the unit and the surroundings, condensation (dew) may form on the operating parts inside the unit, causing the unit not to operate properly.

If this happens, let the unit sit for an hour or two with the power turned off and wait until there is little difference in temperature before using the unit.

### • Cautions on using mobile phones

Using a mobile phone near this unit may result in noise. If so, move the mobile phone away from this unit when it is in use.

### • Moving the unit

Turn off the power and unplug the power cord from the power outlet. Next, disconnect the connection cables to other system units before moving the unit.

### • About Care

- Wipe the cabinet and control panel clean with a soft cloth.
- Follow the instructions when using a chemical cleaner.
- Benzene, paint thinner or other organic solvents as well as insecticide may cause material changes and discoloration if brought into contact with the unit, and should, therefore, not be used.

# Simple version (Simple setup guide)

Here, we explain the entire setup procedure, from unboxing the unit to using it in a home theater. The "Simple version" describes the installation, connection and setup methods for 5.1-channel speakers. See page 30 for the installation, connection and setup methods for speakers other than 5.1-channel speakers.

- ❑ Before connecting the unit, turn off the power to all devices.
- ❑ For operation of the connected devices, refer to the user manuals for each device.

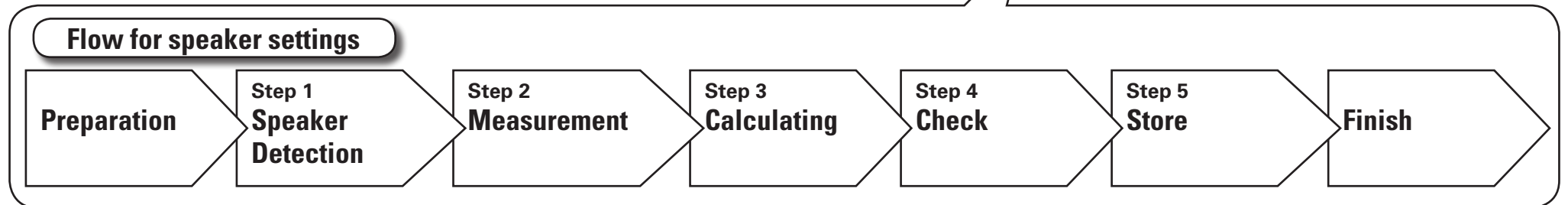
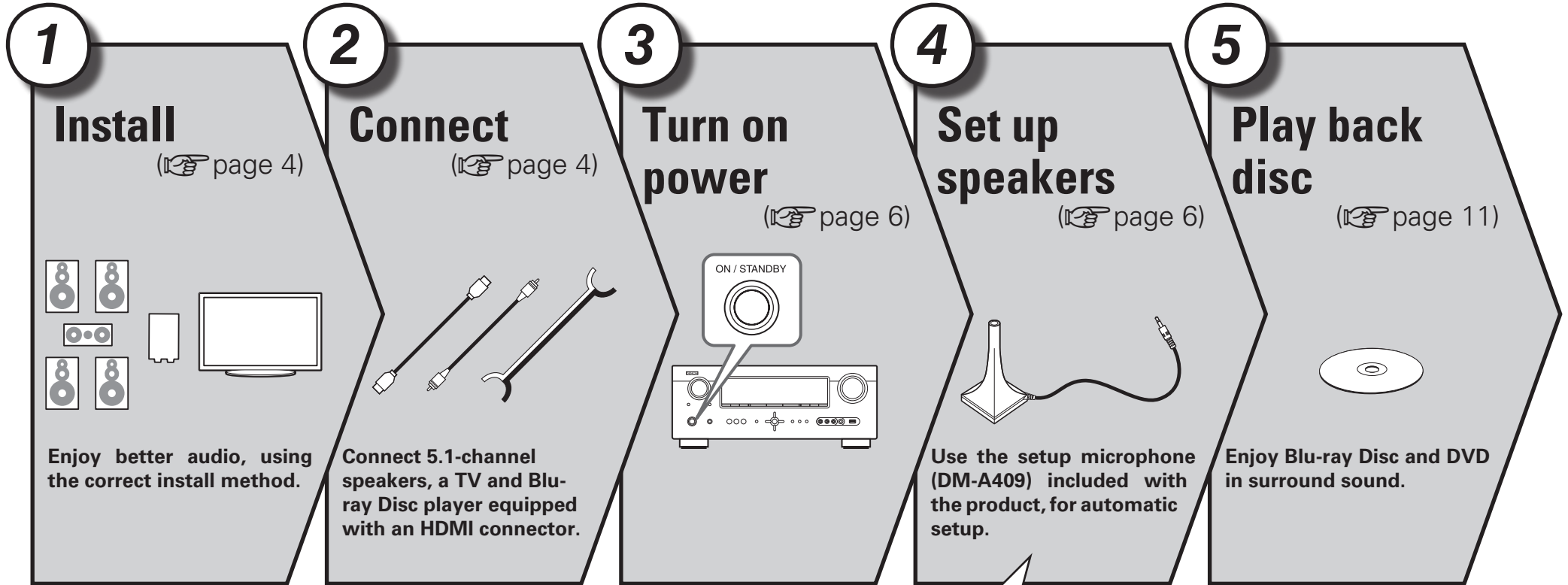

# 1 Install



This unit can perform 2.0/2.1 to 7.1-channel surround playback. Here, we explain setup using the example of 5.1-channel speaker playback.

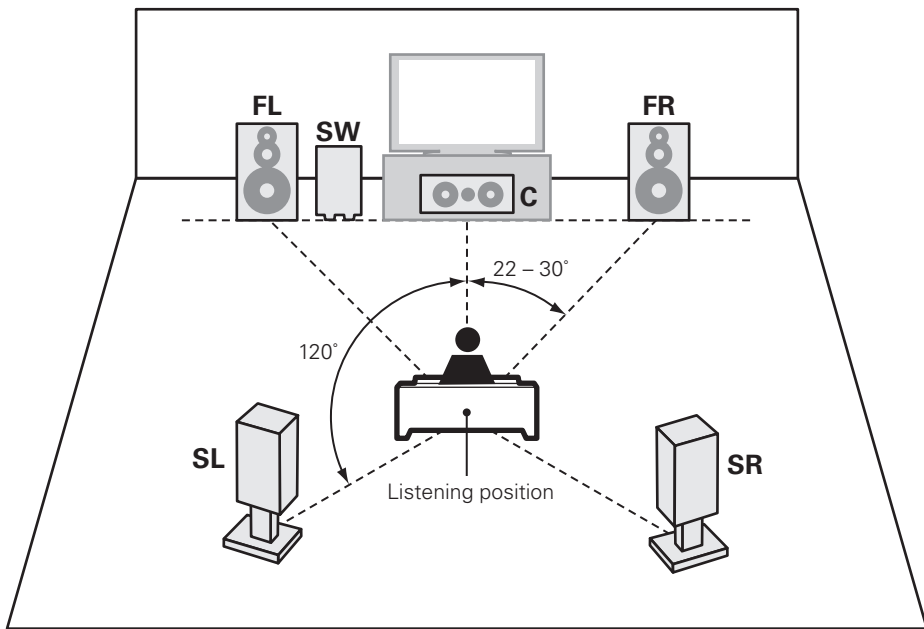

- FL** Front speaker (L)
- FR** Front speaker (R)
- C** Center speaker
- SW** Subwoofer
- SL** Surround speaker (L)
- SR** Surround speaker (R)

- Install the surround speakers in a position 2 to 3 ft (60 to 90 cm) higher than ear level.

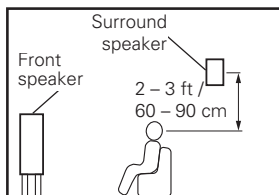

[Viewed from the side]

# 2 Connect



## Speakers

Carefully check the left (L) and right (R) channels and + (red) and - (black) polarities on the speakers being connected to the this unit, and be sure to interconnect the channels and polarities correctly.

### Connecting the speaker cables

Peel off about 0.03 ft/10 mm of sheathing from the tip of the speaker cable, then either twist the core wire tightly or terminate it.

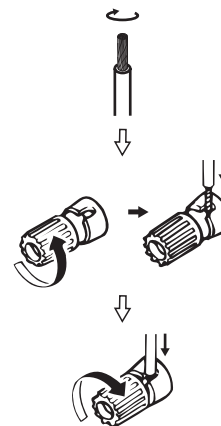

### When using a banana plug

Tighten the speaker terminal firmly before inserting the banana plug.



### NOTE

- Connect so that the speaker cable core wires do not protrude from the speaker terminal. The protection circuit may be activated if the core wires touch the rear panel or if the + and - sides touch each other (see page 75 "Protection Circuit").
- Never touch the speaker terminals while the power supply is connected. Doing so could result in electric shock.
- Use speakers with the speaker impedances shown below.

Speaker terminals	Speaker impedance
FRONT	6 - 16 Ω
CENTER	
SURROUND	
SURR. BACK / AMP ASSIGN	

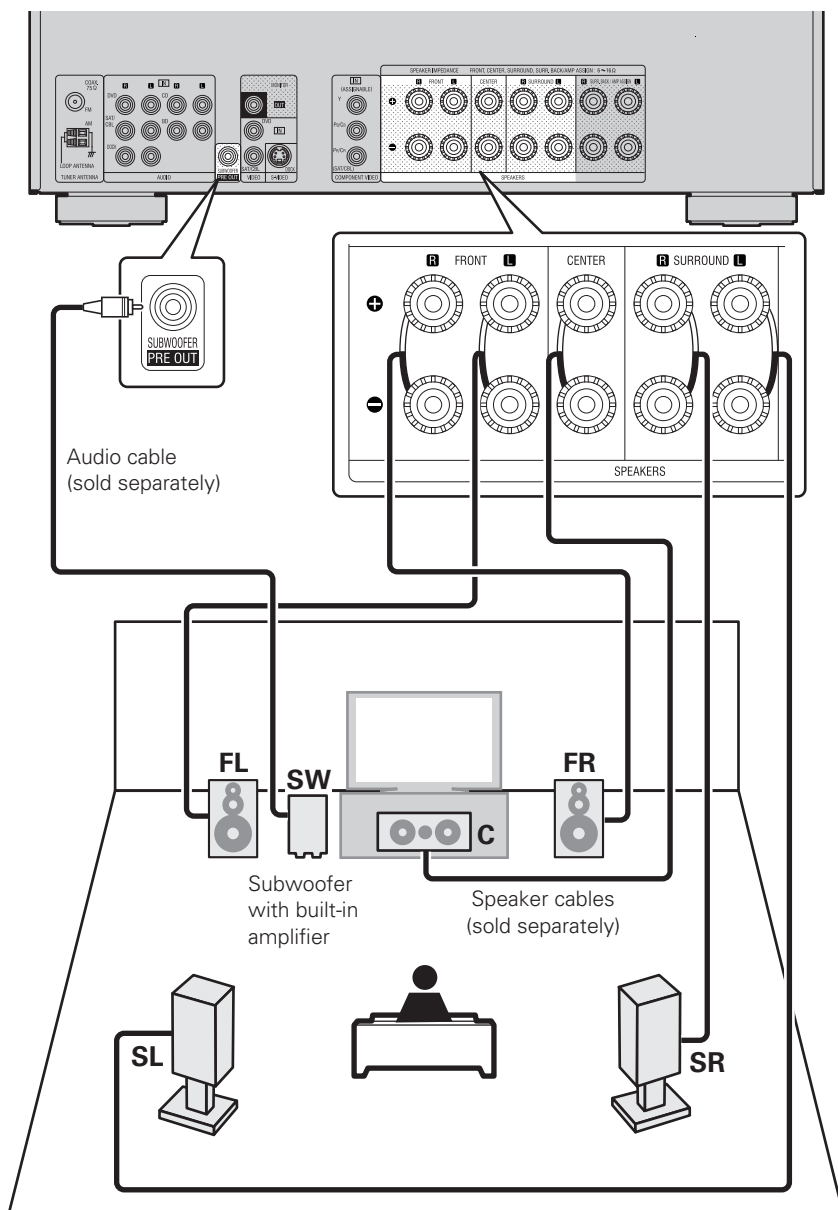

**Blu-ray Disc player and TV**

Use only HDMI (High Definition Multimedia Interface) cable that bears the HDMI logo (genuine HDMI product). Using cable without the HDMI logo (non-genuine HDMI product) may result in abnormal playback. When outputting Deep Color or 1080p, etc., we recommend you use "High Speed HDMI cable" or "High Speed HDMI cable with Ethernet" for enhanced high-quality playback.

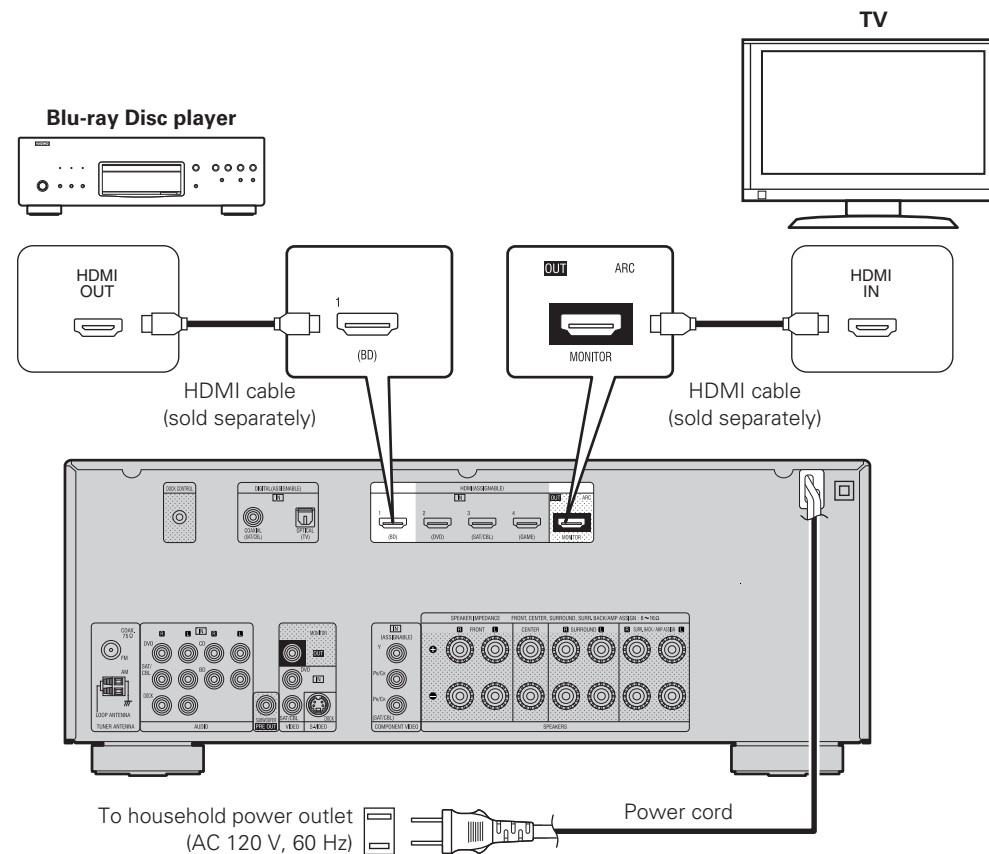

- NOTE**
- Do not plug in the power cord until all connections have been completed.
  - Do not bundle power cords together with connection cables. Doing so can result in humming or noise.



## 3 Turn on power



- 1** Turn on the TV and subwoofer power.

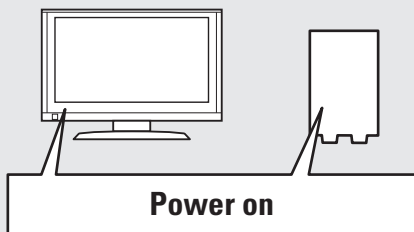

- 2** Change the TV input to the input of this unit.

- 3** Press **POWER ON** to turn on power to the unit.

The power indicator flashes green and the power turns on.

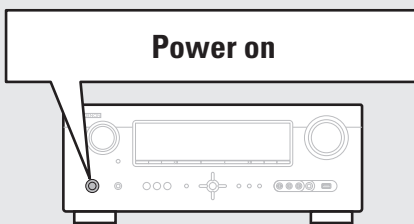
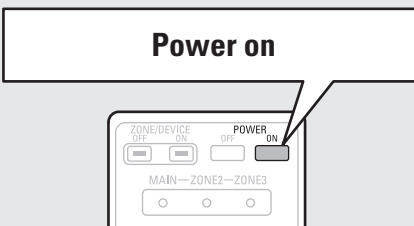

## 4 Set up speakers (Audyssey® Auto Setup)



The acoustic characteristics of the connected speakers and listening room are measured and the optimum settings are made automatically. This is called “Audyssey Auto Setup”.

To perform measurement, place the setup microphone in multiple locations all around the listening area. For best results, we recommend you measure in six positions, as shown in the illustration (up to six positions).

- When performing Audyssey Auto Setup, MultEQ®/Dynamic EQ®/Dynamic Volume™ functions become active (☞ page 49, 50).
- To set up the speakers manually, use “Speaker Setup” (☞ page 52) on the menu.

### NOTE

- Make the room as quiet as possible. Background noise can disrupt the room measurements. Close windows, silence cell phones, televisions, radios, air conditioners, fluorescent lights, home appliances, light dimmers, or other devices as measurements may be affected by these sounds.
- Cell phones should be placed away from all audio electronics during the measurement process as Radio Frequency Interference (RFI) may cause measurement disruptions (even if the cell phone is not in use).
- Do not unplug the setup microphone from the main unit until Audyssey Auto Setup is completed.
- Do not stand between the speakers and setup microphone or allow obstacles in the path while the measurements are being made. This will cause inaccurate readings.
- Loud test sounds may be played during Audyssey Auto setup. This is part of normal operation. If there is background noise in room, these test signals will increase in volume.
- Operating **VOL ▲▼** during the measurements will cancel the measurements.
- Measurement cannot be performed when headphones are connected.

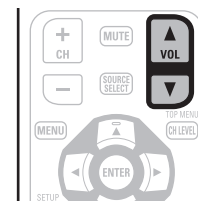

### About setup microphone placement

- Measurements are performed by placing the setup microphone successively at multiple positions throughout the entire listening area, as shown in **[Example ①]**. For best results, we recommend you measure in six positions, as shown in the illustration (up to six positions).
- Even if the listening environment is small as shown in **[Example ②]**, measuring at multiple points throughout the listening environment results in more effective correction.

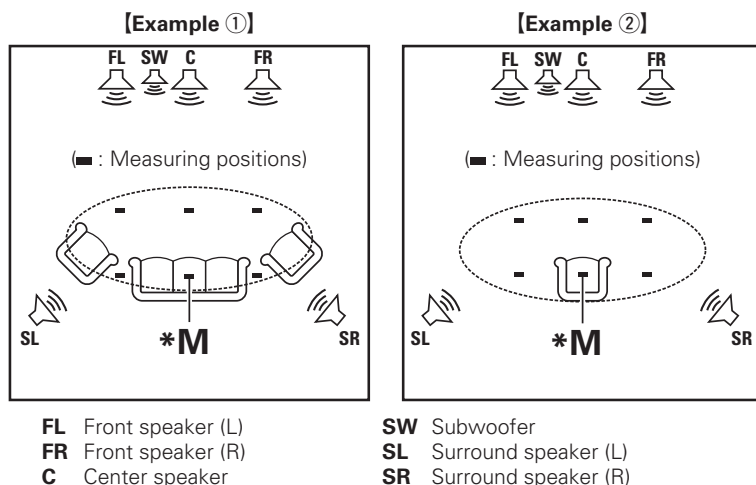

### About the main listening position (\*M)

The main listening position is the position where listeners would normally sit or where one would normally sit alone within the listening environment. Before starting Audyssey Auto Setup, place the setup microphone in the main listening position. Audyssey MultEQ® uses the measurements from this position to calculate speaker distance, level, polarity, and the optimum crossover value for the subwoofer.

### 1 Set up the microphone

Mount the setup microphone on a tripod or stand and place it in the main listening position.

When placing the setup microphone, adjust the height of the sound receptor part to the level of the listener's ear.

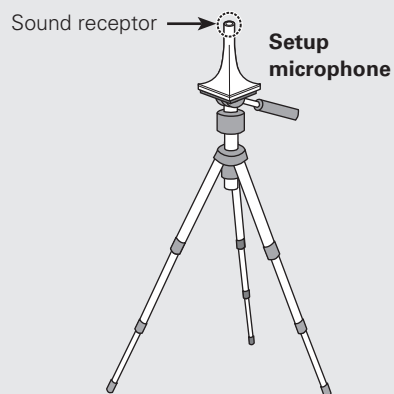

#### NOTE

- Do not hold the setup microphone in your hand during measurements.
- Avoid placing the setup microphone close to a seat back or wall as sound reflections may give inaccurate results.

### 2 Set up the subwoofer

If using a subwoofer capable of the following adjustments, set up the subwoofer as shown below.

#### When using a subwoofer with a direct mode

Set the direct mode to "On" and disable the volume adjustment and crossover frequency setting.

#### When using a subwoofer without a direct mode

Make the following settings:

- **Volume** : "12 o'clock position"
- **Crossover frequency** : "Maximum/Highest Frequency"
- **Low pass filter** : "Off"
- **Standby mode** : "Off"

Set up speakers (Audyssey® Auto Setup)

**3 Set up the remote control unit**

❑ **Set up the zone mode**  
Press **ZONE SELECT** to switch the zone mode to “MAIN”. The “MAIN” indicator lights.

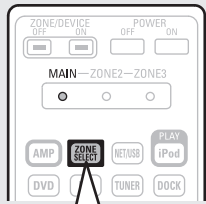

Press **ZONE SELECT**

❑ **Set up the operation mode**  
Press **AMP** to set the remote control unit to amplifier operation mode.

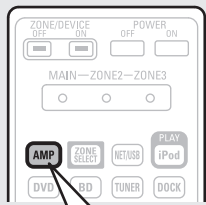

Press **AMP**

**Preparation**

**4** Connect the setup microphone to the **SETUP MIC** jack of this unit.

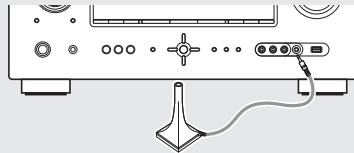

When the setup microphone is connected, the following screen is displayed.

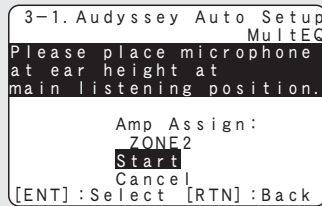

Here, we explain setup using the example of 5.1-channel speaker playback. For setting other than 5.1-channel surround, select “Amp Assign” and perform steps 3 to 4 of “Set up speakers” (page 33).

**5** Use  $\Delta$ / $\nabla$  to select “Start” and then press **ENTER**.

When measuring begins, a test tone is output from each speaker.

- Measuring requires several minutes.

**If “Cancel” is selected**

“Cancel Auto Setup?” is displayed on the TV screen. If “Yes” is selected, “Audyssey Auto Setup” closes.

**Step 1 Speaker Detection**

**6** The detected speakers are displayed.

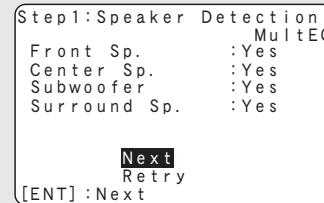

**NOTE**

If a connected speaker is not displayed, the speaker may not be connected correctly. Check the speaker connection.

**7** Use  $\Delta$ / $\nabla$  to select “Next” and then press **ENTER**.

**NOTE**

**If “Caution” is displayed:**

Go to “Error messages” (page 10), check any related items, and perform the necessary procedures.

If the problem is resolved, return and restart “Audyssey Auto Setup”.

**When performing Audyssey Auto Setup over again**

Press  $\Delta$ / $\nabla$  to select “Retry”, and then press **ENTER**.

**When measuring has stopped**

- ① Press  $\Delta$ / $\nabla$  to select “Cancel”, then press **ENTER**.
- ② Press  $\triangleleft$ / $\triangleright$  to select “Yes”, then press **ENTER**.

**Setting up the speakers again**

Repeat the operation from step 4 of **Preparation**

**Step 2 Measurement**

**8** Move the setup microphone to position 2, use  $\Delta$ / $\nabla$  to select “Next”, and then press **ENTER**.

The measurement of the second position starts. Measurements can be made in up to six positions.

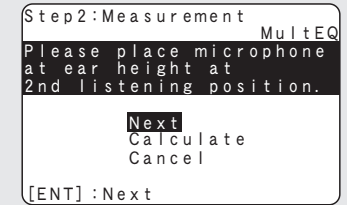

If you want to omit measurements from the next position onward, select “Calculate”. (Go to **Step 3 Calculating**)

**9** Repeat step 8, measuring positions 3 to 6.

When measurement of position 6 is completed, a “All the measurements were finished.” message is displayed.

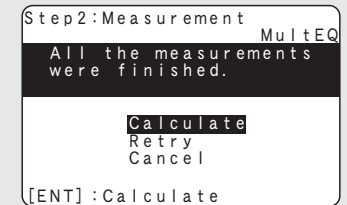

**Step 3  
Calculating**

**10** On the **Step 2** screen, use  $\Delta$ / $\nabla$  to select “Calculate”, and then press **ENTER**.

Measuring results are analyzed, and the frequency response of each speaker in the listening room is determined.

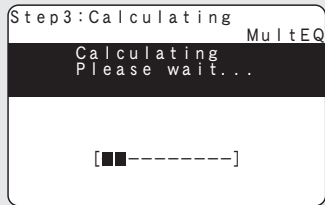

- Analysis takes several minutes to complete. The time required for this analysis depends on the number of speakers connected. The more connected speakers there are, the longer it takes to perform analysis.

**Step 4  
Check**

**11** Use  $\Delta$ / $\nabla$  to select the item you want to check, and then press **ENTER**.

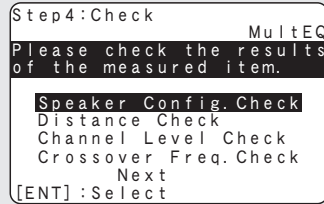

- Subwoofers may measure a greater reported distance than the actual distance due to added electrical delay common in subwoofers.
- If you want to check another item, press **RETURN**.

**12** Use  $\Delta$ / $\nabla$  to select “Next” and then press **ENTER**.

**NOTE**

- If the result differs from the actual connection status, or if “Caution!” is displayed, see “Error messages” (page 10). Then carry out Audyssey Auto Setup again.
- If the result still differs from the actual connection status after remeasurement or the error message still appears, it is possible that the speakers are not connected properly. Turn this unit off, check the speaker connections and repeat the measurement process from the beginning.
- If you change a speaker position or orientation, perform Audyssey Auto Setup again to obtain optimal equalizer correction.

**Step 5  
Store**

**13** Use  $\Delta$ / $\nabla$  to select “Store” and then press **ENTER**.

Save the measuring results.

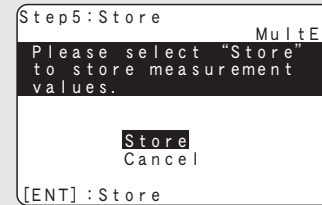

- Saving the results requires about 10 seconds.
- If you do not want to save the measurement results, use  $\Delta$ / $\nabla$  to select “Cancel”, then select “Yes” using  $\triangleleft$ / $\triangleright$ . All the measured Audyssey Auto Setup data will be erased.

**NOTE**

During saving of measuring results, be sure not to turn off the power.

**Finish**

**14** Unplug the setup microphone from the unit’s SETUP MIC jack.

**15** Set Dynamic Volume™.

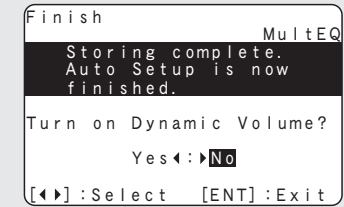

- For details of Dynamic Volume settings, see page 50.

- When turning Dynamic Volume on**
  - Use  $\triangleleft$  to select “Yes”, and then press **ENTER**. The unit automatically enters “Evening” mode.
- When turning Dynamic Volume off**
  - Use  $\triangleright$  to select “No”, and then press **ENTER**.

**NOTE**

After performing Audyssey Auto Setup, do not change the speaker connections or subwoofer volume. In event of a change, perform Audyssey Auto Setup again.



# Error messages

An error message is displayed if Audyssey® Auto Setup could not be completed due to speaker placement, the measurement environment, etc. If this happens, check the relevant items, be sure to take the necessary measures, then perform Audyssey Auto Setup over again.

**NOTE**

Be sure to turn off the power before checking speaker connections.

Examples	Error details	Measures
	<ul style="list-style-type: none"> <li>The connected setup microphone is broken, or a device other than the supplied setup microphone is connected.</li> <li>Not all speakers could be detected.</li> <li>The front L speaker was not properly detected.</li> </ul>	<ul style="list-style-type: none"> <li>Connect the included setup microphone to the SETUP MIC jack of this unit.</li> <li>Check the speaker connections.</li> </ul>
	<ul style="list-style-type: none"> <li>There is too much noise in the room for accurate measurements to be made.</li> <li>Speaker or subwoofer sound is too low for accurate measurements to be made.</li> </ul>	<ul style="list-style-type: none"> <li>Either turn off any device generating noise or move it away.</li> <li>Perform again when the surroundings are quieter.</li> <li>Check the speaker installation and the direction in which the speakers are facing.</li> <li>Adjust the subwoofer's volume.</li> </ul>
	<ul style="list-style-type: none"> <li>The displayed speaker could not be detected.</li> </ul>	<ul style="list-style-type: none"> <li>Check the connections of the displayed speaker.</li> </ul>
	<ul style="list-style-type: none"> <li>The displayed is connected with the polarities reversed.</li> </ul>	<ul style="list-style-type: none"> <li>Check the polarities of the displayed speaker.</li> <li>For some speakers, this error message may be displayed even if the speaker is properly connected. If you are sure the connection is correct, press <math>\Delta \nabla</math> to select "Skip", then press <b>ENTER</b>.</li> </ul>

# Parameter Check

Enables you to check the measurement results and equalizer characteristics after Audyssey Auto Setup.

**1** Use  $\Delta \nabla$  to select "Parameter Check" and then press **ENTER**.

**2** Use  $\Delta \nabla$  to select the item you want to check, then press **ENTER**.

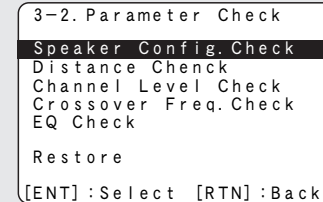

- Speaker Config. Check** Check the speaker configuration.
- Distance Check** Check the distance.
- Channel Level Check** Check the channel level.
- Crossover Freq. Check** Check the crossover frequency.
- EQ Check** Check the equalizer.

• If "EQ Check" is selected in step 2, press  $\Delta \nabla$  to select equalizing curve ("Audyssey" or "Audyssey Flat") to be checked. Use  $\triangleleft \triangleright$  to switch the display between the different speakers.

**3** Press **RETURN**.  
The confirmation screen reappears. Repeat steps 2 and 3.

## Retrieving Audyssey Auto Setup settings

If you set "Restore" to "Yes", you can return to Audyssey Auto Setup measurement result (value calculated at the start by MultEQ®) even when you have changed each setting manually.



# 5 Play back disc



**1** Press **BD** to switch an input source for a player used for playback.

**2** Play the component connected to this unit.  
Make the necessary settings on the player (language setting, subtitles setting, etc.) beforehand.

**3** Adjust the sound volume.  
VOL ▲ ..... Volume up  
VOL ▼ ..... Volume down  
MUTE ..... Muting

**4** Set the listening mode.  
Set the listening mode according to the playback contents (cinema, music, etc.) or according to your liking (page 26 "Selecting a listening mode (Surround mode)").

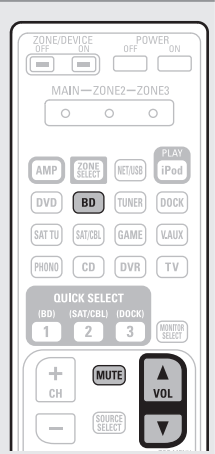

## When power is switched to standby

Press **POWER OFF**.

- [Power indicator status in standby mode]**
- Normal standby : Off
  - When "HDMI Control" is set to "ON" : Red

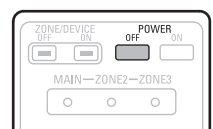

You can also switch the power to standby by pressing **ON/STANDBY** on the main unit.

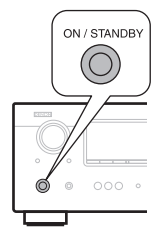

### NOTE

During power standby, a slight amount of power is consumed. To totally cut off the power, remove the power cord from the power outlet.



## Basic version

Here, we explain the connections and basic operation methods for this unit.

- Connections
- Playback (Basic operation)
- Selecting a listening mode (Surround mode)

☐ Refer to the pages indicated below for information on connecting and playing back the various media and external devices.

Audio and video	Connection	Playback
TV	☞ page 14, 16	–
Blu-ray Disc player	☞ page 14, 16	☞ page 21
DVD player	☞ page 14, 16	☞ page 21
Set-top box (Satellite tuner or cable TV)	☞ page 14, 17	–
Game console	☞ page 14	–
Digital camcorder	☞ page 17	–
Control dock for iPod	☞ page 18	☞ page 21

Audio	Connection	Playback
iPod®	☞ page 18	☞ page 22
USB memory device	☞ page 18	☞ page 25
CD player	☞ page 19	☞ page 21
Radio	☞ page 19	☞ page 24

For speaker connections, see page 4.

# Connections

## Important information

- Connect this unit as follows before using. Make connections according to the equipment you are connecting.
- Some settings of this unit may be necessary depending on the connection method. Check each connection item for more information.
- Select the cables (sold separately) according to the components being connected.

### NOTE

- Do not plug in the power cord until all connections have been completed.
- When making connections, also refer to the operating instructions of the other components being connected.
- Be sure to connect the left and right channels properly (left with left, right with right).
- Do not bundle power cords together with connection cables. Doing so can result in noise.

## Converting input video signals for output (Video conversion function)

This unit is equipped with four types of video input connectors (HDMI, Component video, S-Video and video) and two types of video output connectors (HDMI and video).

Use the connectors corresponding to the components to be connected.

This function automatically converts various formats of video signals input to this unit into the formats used to output the video signals from this unit to a monitor.

### (Flow of video signals for MAIN ZONE)

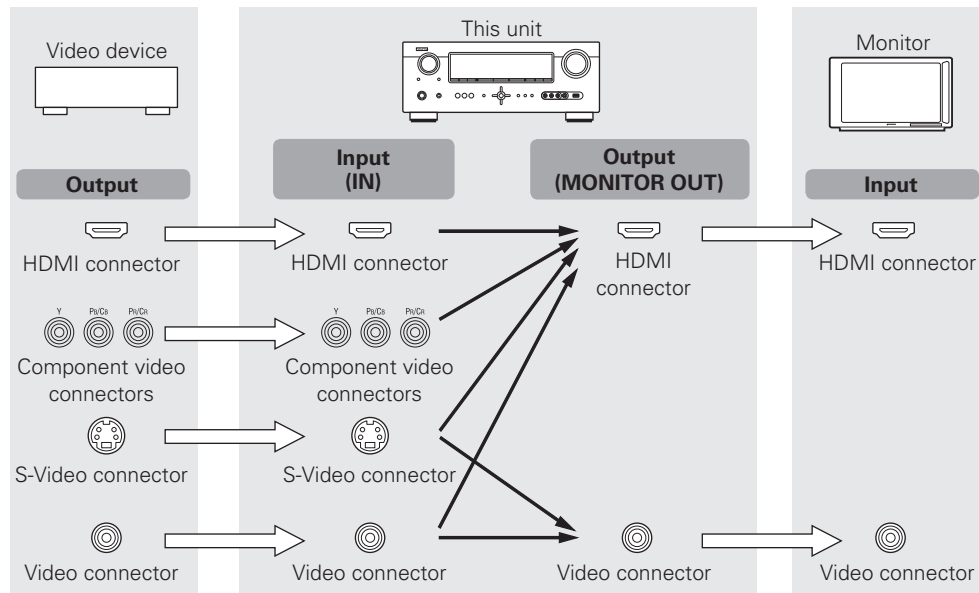

### in Set as Necessary

Set when changing the resolution of the video signal.

"Resolution" (page 45)



- The video conversion function supports the NTSC, PAL, SECAM, NTSC 4.43, PAL-N, PAL-M and PAL-60 formats.
- The resolution of the video signal input to this unit's HDMI connector is the resolution set at "Resolution" (page 45) (1080p HDMI signals and 1080p component signals are output at 1080p, regardless of the setting).
- Resolutions of HDMI-compatible TVs can be checked at "HDMI Monitor Information" (page 59).

### NOTE

- HDMI signals cannot be converted into analog signals.
- When a non-standard video signal from a game machine or some other source is input, the video conversion function might not operate.
- Component video input signals cannot be converted into Video format.



## Important information

## How the on-screen display is displayed depending on the video input signal

The way the on-screen display of the menus, status, etc., is displayed differs according to the type of video signal input to this unit.

### □ When video signals are input from the HDMI or component video connectors

- **Menu:** Switches to a screen with a black background and the menu is superimposed\*.
- **Status display:** Not displayed.

\* If you want to display the menus superimposed on the picture being played, input the same video signals to the video connectors. When a menu is displayed, the picture switches to the one being input from the video connectors and the menu is displayed superimposed over this picture.

### □ When video signals are being input from the S-Video or video Connectors

- **Menu:** Menus are displayed superimposed over the picture being played.
- **Status display:** Displayed.

### Examples of on-screen display

- Menu screen
- Status display screen  
When the input source is switched
- When the volume is adjusted

```

MENU
1. Audio Adjust
2. Information
3. Auto Setup
4. Manual Setup
5. Input Setup
[ENT] : Select
  
```

```

          [Auto]
IN  : DVD
MODE: STEREO
  
```

```

Master Volume -80.0dB
  
```

Status display: The operating status is displayed temporarily on the screen when the input source is switched or the volume is adjusted.

## Connecting an HDMI-compatible device

You can connect up to five HDMI-compatible devices to the unit.

### HDMI function

This unit supports the following HDMI functions:

- High resolution video signal
- 3D
- Deep Color (👉 page 74)
- Auto Lip Sync (👉 page 55)
- x.v.Color, sYCC601 color, Adobe RGB color, Adobe YCC601 color (👉 page 74, 75)
- High definition digital audio format
- ARC (Audio Return Channel)
- Content Type
- CEC (HDMI control)

### Copyright protection system

In order to play back digital video and audio such as BD-Video or DVD-Video via HDMI connection, both this unit and TV or the player need to support the copyright protection system known as HDCP (High-bandwidth Digital Content Protection System). HDCP is copyright protection technology comprised of data encryption and authentication of the connected AV device. This unit supports HDCP.

- If a device that does not support HDCP is connected, video and audio are not output correctly. Read the owner's manual of your television or player for more information.

### About HDMI cables

- When a device supporting Deep Color signal transfer is connected, use a cable compatible "High Speed HDMI cable" or "High Speed HDMI cable with Ethernet"
- When the ARC function is used, connect a device with a "Standard HDMI cable with Ethernet" or "High Speed HDMI cable with Ethernet" for HDMI 1.4.

### HDMI control function (👉 page 34)

This function allows you to operate external devices from the receiver and operate the receiver from external devices.

#### NOTE

- The HDMI control function may not work depending on the device it is connected to and its settings.
- You cannot operate a TV or Blu-ray Disc player / DVD player that is not compatible with the HDMI control function.

### About 3D function

This unit supports input and output of 3D (3 dimensional) video signals of the HDMI 1.4 standards, For playing the 3D video content, a player, and a TV that support the 3D function of the HDMI 1.4 standards are required in addition to this unit.

### About ARC (Audio return channel) function

The Audio Return Channel in HDMI 1.4 enables a TV, via a single HDMI cable, to send audio data “upstream” to this unit, increasing user flexibility and eliminating the need for any separate S/PDIF audio connection.

**NOTE**

To enable the ARC function, set “HDMI Control” to “ON” (☞ page 55).

### About Content Type

The HDMI Specification Version 1.4 enables simple, automated picture setting selection with no user intervention.

The Content Type feature enables a display to auto-select the correct viewing mode to match the content type it is currently receiving from a source device, and to switch modes when a new content source is selected. Content Type supports content profiles for gaming, movie, photograph, and text viewing modes.

**NOTE**

To enable the Content type, set “Video Mode” to “Auto” (☞ page 45).

### Cables used for connections

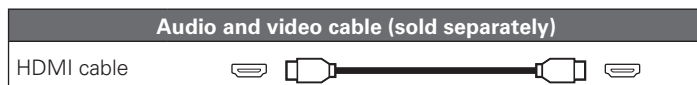

- This interface allows transfer of digital video signals and digital audio signals over a single HDMI cable.

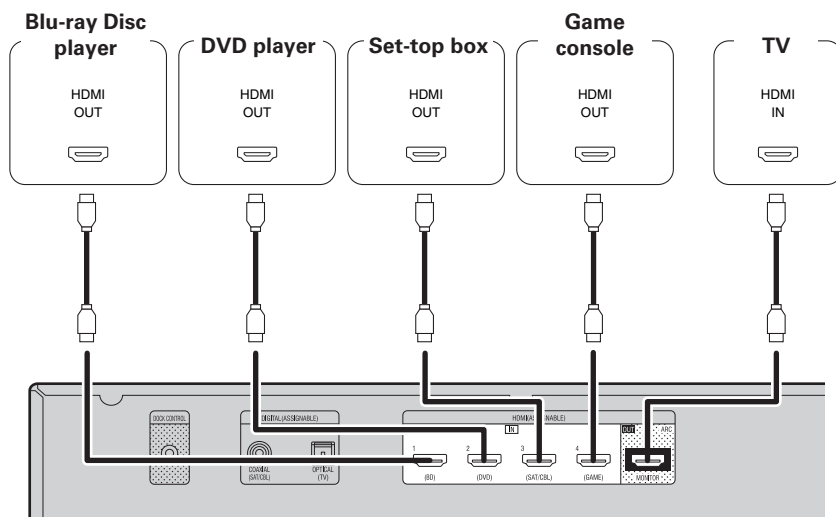

- When this unit is connected to other devices with HDMI cables, also connect this unit and TV using an HDMI cable.
- When connecting a device that supports Deep Color transmission, please use a “High Speed HDMI cable” or “High Speed cable with Ethernet”.
- Video signals are not output if the input video signals do not match the monitor’s resolution. In this case, switch the Blu-ray Disc/DVD player’s resolution to a resolution with which the monitor is compatible.
- When this unit and monitor are connected with an HDMI cable, if the monitor is not compatible with HDMI audio signal playback, only the video signals are output to the monitor.

**NOTE**

The audio signal from the HDMI output connector (sampling frequency, number of channels, etc.) may be limited by the HDMI audio specifications of the connected device regarding permissible inputs.

### Connecting to a device equipped with a DVI-D connector

When an HDMI/DVI conversion cable (sold separately) is used, the HDMI video signals are converted to DVI signals, allowing connection to a device equipped with a DVI-D connector.

**NOTE**

- No sound is output when connected to a device equipped with a DVI-D connector. Make separate audio connections.
- Signals cannot be output to DVI-D devices that do not support HDCP.
- Depending on the combination of devices, the video signals may not be output.

### Settings related to HDMI connections

Set as necessary. For details, see the respective reference pages.

#### Input Assign (☞ page 44)

Set this to change the HDMI input connector to which the input source is assigned.

#### HDMI Setup (☞ page 55)

Make settings for HDMI video/audio output.

- Auto Lip Sync
- HDMI Audio Out
- HDMI Control
- Standby Source
- Power Off Control

**NOTE**

The audio signals output from the HDMI connectors are only the HDMI input signals.

## Connecting a TV

- Select the connector to use and connect the device.
- For video connections, see “Converting input video signals for output (Video conversion function)” (📖 page 13).
- For instructions on HDMI connections, see “Connecting an HDMI-compatible device” (📖 page 14).



To listen to TV audio through this device, use the optical digital connection.

### NOTE

This connection is not required when a TV compatible with the ARC function (Audio Return Channel (HDMI 1.4 standard function)) is connected to this unit via an HDMI connection.

For details, see “About ARC (Audio return channel) function” (📖 page 15) or refer to the instruction manual for your TV.

## Cables used for connections

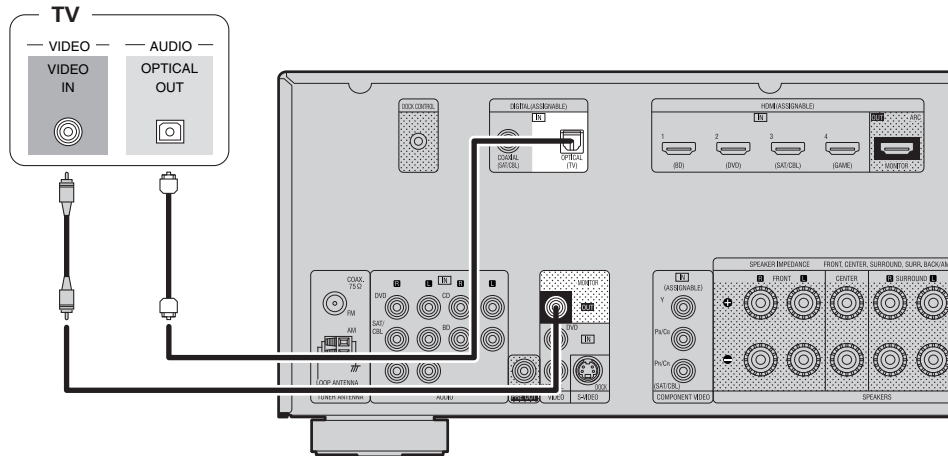
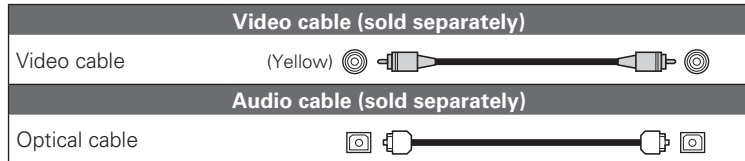

### in Set as Necessary

Set this to change the digital input connector to which the input source is assigned.  
**“Input Assign”** (📖 page 44)

## Connecting a Blu-ray Disc player / DVD player

- You can enjoy video and audio from a Blu-ray Disc or DVD.
- Select the connector to use and connect the device.
- For instructions on HDMI connections, see “Connecting an HDMI-compatible device” (📖 page 14).

## Cables used for connections

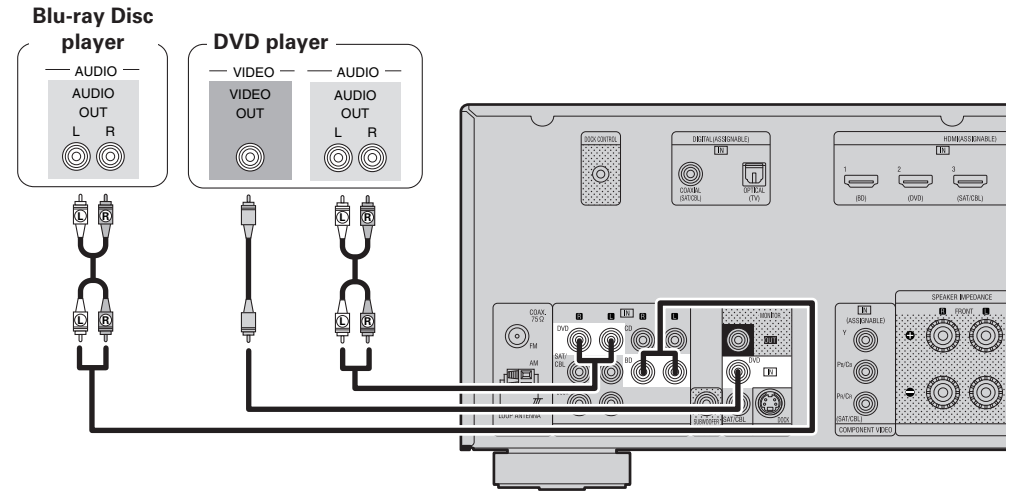
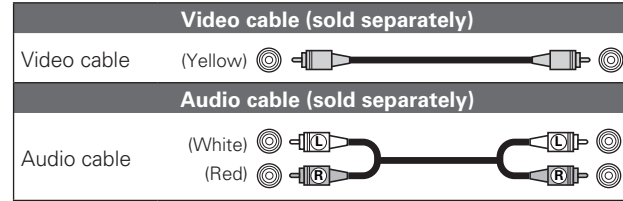

### in Set as Necessary

Set this to change the digital input connector to which the input source is assigned.  
**“Input Assign”** (📖 page 44)



For HD audio (Dolby TrueHD, DTS-HD, Dolby Digital Plus and DTS Express) playback, connect with HDMI (📖 page 14 “Connecting an HDMI-compatible device”).

## Connecting a set-top box (Satellite tuner/cable TV)

- You can watch satellite or cable TV.
- Select the connector to use and connect the device.
- For instructions on HDMI connections, see “Connecting an HDMI-compatible device” (page 14).

### Cables used for connections

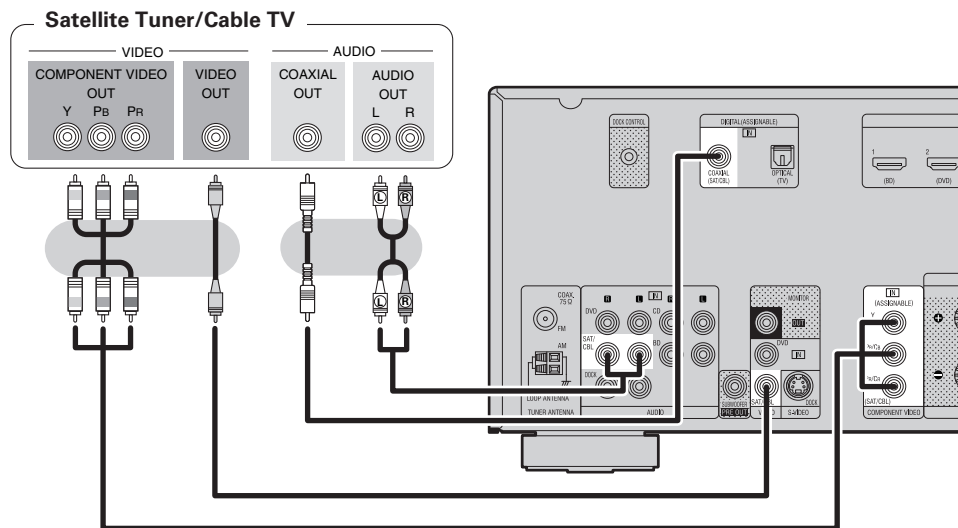
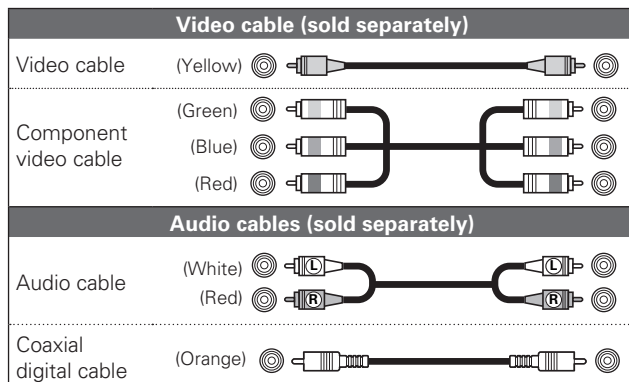

#### in Set as Necessary

Set this to change the digital input connector or component video input connector to which the input source is assigned.  
**“Input Assign”** (page 44)

## Connecting a digital camcorder

- You can enjoy video and audio from a digital camcorder.
- For instructions on HDMI connections, see “Connecting an HDMI-compatible device” (page 14).

### Cables used for connections

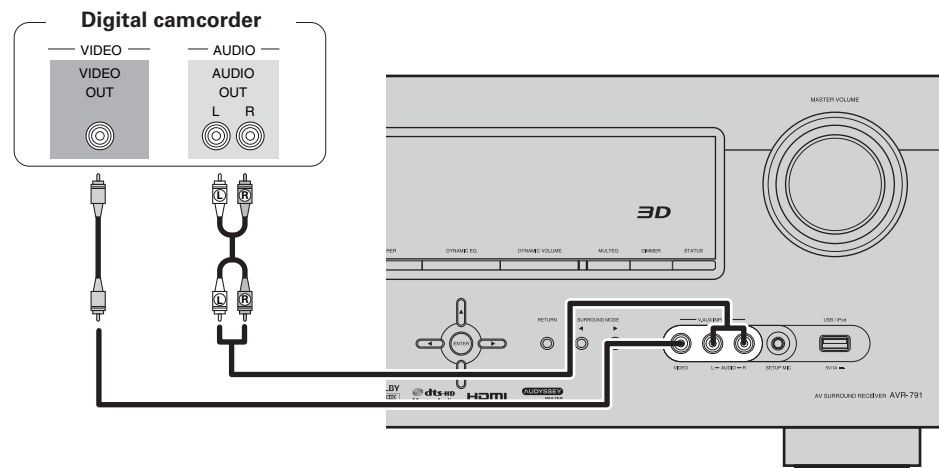
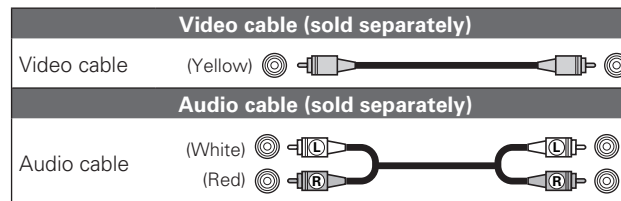

#### in Set as Necessary

Set this to change the digital input connector to which the input source is assigned.  
**“Input Assign”** (page 44)



You can enjoy games by connecting a game machine via the V.AUX input connector. In this case, set the input source to “V.AUX”.

#### NOTE

When a non-standard video signal from a game machine or some other source is input, the video conversion function might not operate. In this case, use the monitor output of the same connector as the input.

## Connecting a control dock for iPod

- Connect the control dock for iPod to the unit to enjoy video and music stored on an iPod.
- For the control dock for iPod, use ASD-1R, ASD-11R, ASD-3N, ASD-3W, ASD-51N and ASD-51W made by DENON (sold separately).
- For instructions on the control dock for iPod settings, refer to the control dock for iPod's operating instructions.

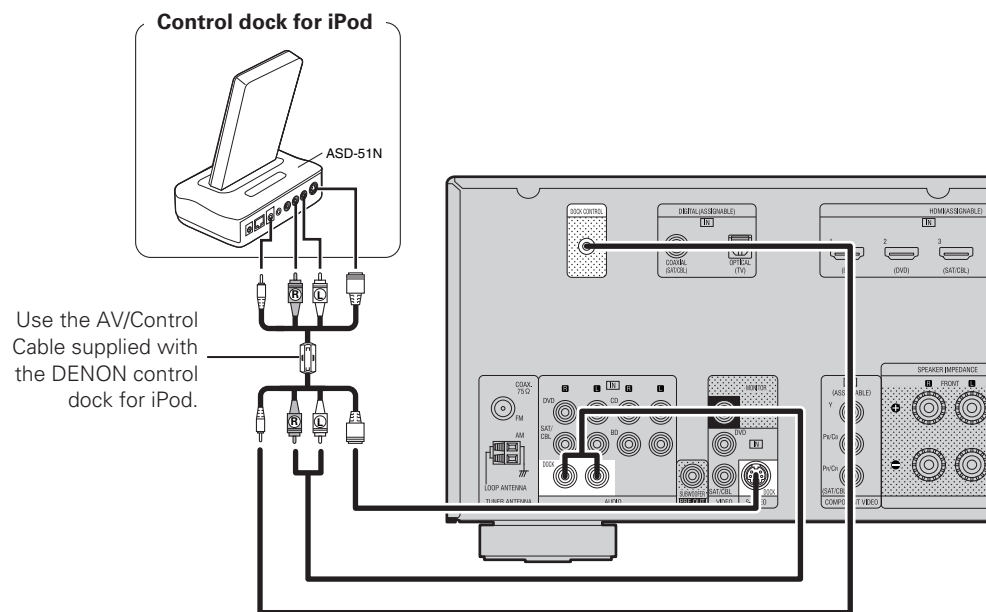

### in Set as Necessary

Set this to change the digital input connector to which the input source is assigned.  
**"Input Assign"** (☞ page 44)



You can also connect the iPod you are using directly to the USB port of this unit (☞ page 18 "Connecting an iPod or USB memory device to the USB Port").

## Connecting an iPod or USB memory device to the USB Port

You can enjoy music, stored on the iPod or USB memory device.

### Cables used for connections

To connect an iPod to this unit, use the USB cable supplied with the iPod.

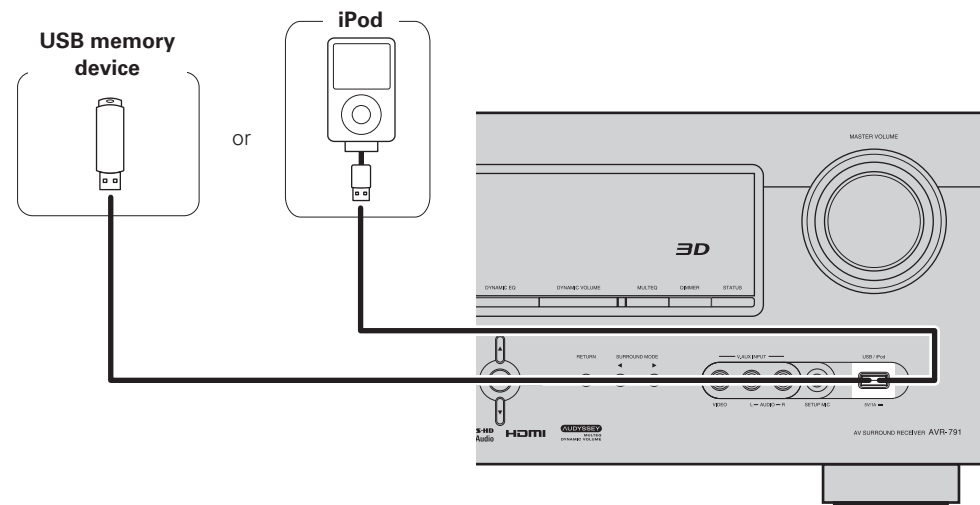

- When you want to playback a video file stored on an iPod, use the DENON control dock for iPod (ASD-1R, ASD-11R, ASD-3N, ASD-3W, ASD-51N and ASD-51W, sold separately) (☞ page 18 "Connecting a control dock for iPod").
- With iPods, playback is possible with iPhone, iPod touch, classic and nano released from the 5th-generation of iPods. For details, check the DENON web site or page 22.
- DENON does not guarantee that all USB memory devices will operate or receive power. When using a portable USB connection type HDD of the kind to which an AC adapter can be connected to supply power, use the AC adapter.

### NOTE

- USB memory devices will not work via a USB hub.
- Do not use an extension cable when connecting a USB memory device. This may cause radio interference with other devices.

## Connecting a CD player

- You can enjoy CD sound.
- Select the connector to use and connect the device.

### Cables used for connections

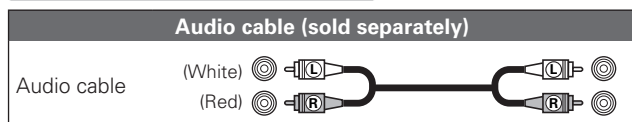

#### CD player

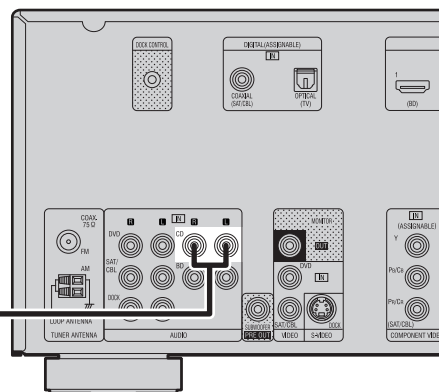
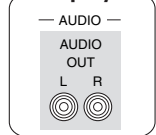

#### in Set as Necessary

Set this to change the digital input connector to which the input source is assigned.  
“Input Assign” (page 44)

## Connecting an antenna

- Connect the FM antenna or AM loop antenna included with the unit to enjoy listening to radio broadcasts.
- After connecting the antenna and receiving a broadcast signal (page 24 “Listening to FM/AM broadcasts”), use tape to fix the antenna in a position where noise is the lowest.

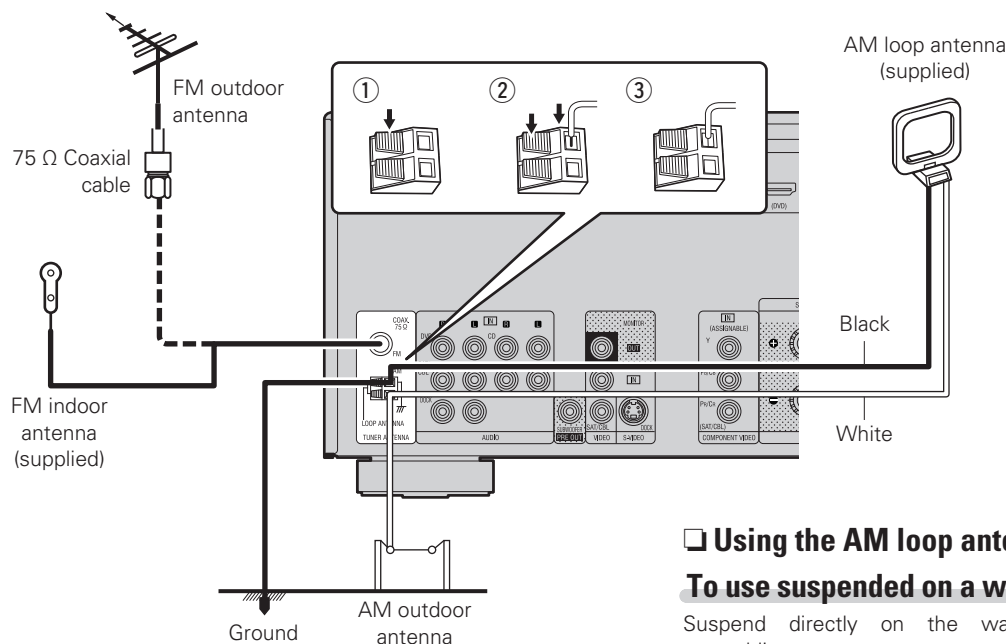

### Using the AM loop antenna

#### To use suspended on a wall

Suspend directly on the wall without assembling.



#### To use standing alone

Use the procedure below to assemble.

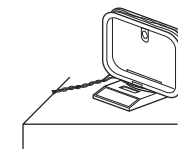

#### NOTE

- Do not connect two FM antennas simultaneously.
- Even if an external AM antenna is used, do not disconnect the AM loop antenna.
- Make sure the AM loop antenna lead terminals do not touch metal parts of the panel.
- If the signal has noise interference, connect the ground terminal (GND) to reduce noise.
- If you are unable to receive a good broadcast signal, we recommend installing an outdoor antenna. Inquire at the retail store where you purchased the unit for details.

### AM loop antenna assembly

**1** Put the stand section through the bottom of the loop antenna from the rear and bend it forward.

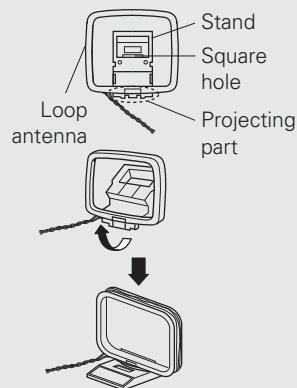

**2** Insert the projecting part into the square hole in the stand.

# Playback (Basic operation)

- ❑ **Selecting the input source** (👉 page 20)
- ❑ **Adjusting the master volume** (👉 page 20)
- ❑ **Turning off the sound temporarily** (👉 page 20)

- ❑ **Playing a Blu-ray Disc player/DVD player**  
(👉 page 21)

- ❑ **Playing a CD player** (👉 page 21)
- ❑ **Playing an iPod®** (👉 page 21)
- ❑ **Tuning in radio stations** (👉 page 24)
- ❑ **Playing a USB memory device** (👉 page 25)

- ❑ **Selecting a listening mode (Surround mode)**  
(👉 page 26)

- ❑ **Playback (Advanced operation)** (👉 page 34)

## Important information

Before starting playback, make the connections between the different components and the settings on the receiver.

### NOTE

Also refer to the operating instructions of the connected components when playing them.

## Selecting the input source

Press the input source select button (**NET/USB, iPod, DVD, BD, TUNER, DOCK, SAT/CBL, GAME, V.AUX, CD, TV**) to be played back.

The desired input source can be selected directly.

- When **iPod PLAY** is pressed, the input source of this unit is switched to "DOCK" or "USB/iPod" and the connected iPod is automatically played (👉 page 23 "iPod play function").



You can also use the following operation to select an input source.

### ❑ Using the "Source Select" menu

- ① Press **SOURCE SELECT**.  
Display the "Source Select" menu.

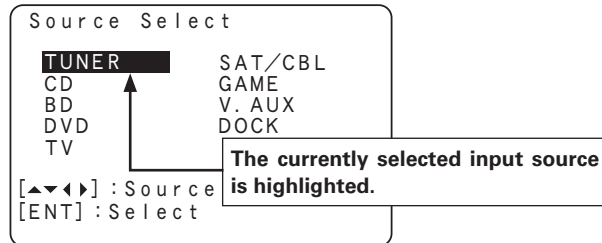

- ② Use  $\Delta \nabla \triangleleft \triangleright$  to select the input source, then press **ENTER**.  
The input source is set and the source selection menu is turned off.

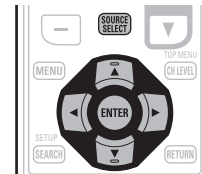

- When using with an iPod connected directly to the USB port of this unit, select "USB/iPod" for the input source.
- Input sources that are not going to be used can be set ahead of time. Make this setting at "Source Delete" (👉 page 57).
- To turn off the source selection menu without selecting an input source, press **SOURCE SELECT** again.

### ❑ Using the knob on the main unit

- Turn **SOURCE SELECT**.
- Turning **SOURCE SELECT** switches the input source, as shown below.

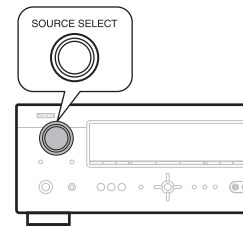

## Adjusting the master volume

Use **VOL ▲▼** to adjust the volume.

- ❑ When the "Volume Display" setting (👉 page 57) is "Relative"  
[Adjustable range] --- -80.5dB - 18.0dB

- ❑ When the "Volume Display" setting (👉 page 57) is "Absolute"  
[Adjustable range] 0.0 - 99.0

- The variable range differs according to the input signal and channel level setting.



You can also operate via the main unit. In this case, perform the following operations.  
Turn **MASTER VOLUME** to adjust the volume.

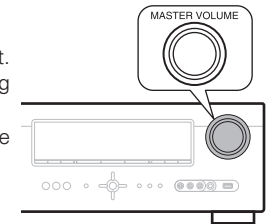

## Turning off the sound temporarily

Press **MUTE**.



- The sound is reduced to the level set at "Mute Level" (👉 page 57).
- To cancel, press **MUTE** again. Muting can also be canceled by adjusting the master volume.

## Playing a Blu-ray Disc player/DVD player

The following describes the procedure for playing Blu-ray Disc player/DVD player.

### 1 Prepare for playback.

- ① Turn on the power of the TV, subwoofer and player.
- ② Change the TV input to the input of this unit.
- ③ Load the disc in the player.



### 2 Press POWER ON to turn on power to the unit.

### 3 Press BD or DVD to switch an input source for a player used for playback.

### 4 Play the component connected to this unit.

Make the necessary settings on the player (language setting, subtitles setting, etc.) beforehand.

## Playing a CD player

The following describes the procedure for playing CD player.

### 1 Prepare for playback.

- ① Turn on the power of the subwoofer and player.
- ② Load the disc in the player.



### 2 Press POWER ON to turn on power to the unit.

### 3 Press CD to switch the input source to the CD player.

### 4 Play the component connected to this unit.

## Playing an iPod®

There are two methods for iPod playback.

- ① **Use the DENON Control dock for iPod to play back.**  
You can play back both video, photo and audio.
- ② **Connect the iPod directly to the USB port to play back.**  
You can play back audio only.

### ① Use the DENON control dock for iPod to play back

DENON Control dock for iPod usable on this unit  
 • ASD-1R/ASD-11R/ASD-3N/ASD-3W/ASD-51N/ASD-51W

#### ❑ Listening to music on an iPod®

### 1 Prepare for playback.

- ① Connect the DENON control dock for iPod to this unit (☞ page 18 "Connecting a control dock for iPod").
- ② Set the iPod® in the DENON control dock for iPod.

### 2 Press POWER ON to turn on power to the unit.

### 3 Press DOCK to switch the input source to "DOCK".

- If "Browse mode" is selected in step 4, the following screen is displayed on a TV screen, depending on the connected control dock for iPod.

【When using an ASD-1R】

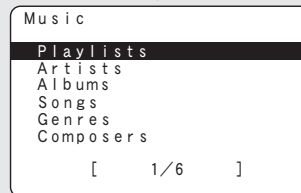

【When using an ASD-11R】

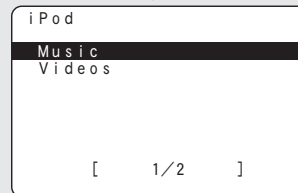

【When using an ASD-3N, ASD-3W, ASD-51N and ASD-51W】

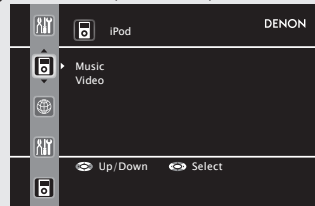

- In "Browse mode", the iPod display is as shown at right.

#### NOTE

If the connections screen is not displayed, the iPod may not be properly connected. Reconnect it.



### 4 Press SEARCH and hold it down for 2 seconds or more to select the display mode.

- There are two modes for display the contents recorded on the iPod.

**Browse mode** Display iPod information on the TV screen.

- English letters, numbers and certain symbols are displayed. Incompatible characters are displayed as "." (period).

**Remote mode** Display iPod information on the iPod screen.

- "Remote iPod" or "Dock Remote" is displayed on the display of this unit.

Display mode		Browse mode	Remote mode
Playable files	Music file	✓	✓
	Photo file		✓ *2
	Video file	✓ *1	✓ *2
Active buttons	Remote control unit (This unit)	✓	✓
	iPod®		✓

\*1 When using an ASD-11R, ASD-3N, ASD-3W, ASD-51N or ASD-51W DENON control dock for iPod.

\*2 Video may not be output, depending on the combination of ASD-1R, ASD-11R, ASD-3N, ASD-3W, ASD-51N or ASD-51W DENON control dock for iPod and iPod.

### 5 Use Δ ▽ to select the item, then press ENTER or ▷ to select the file to be played.

### 6 Press ENTER, ▷ or ►.

Playback starts.

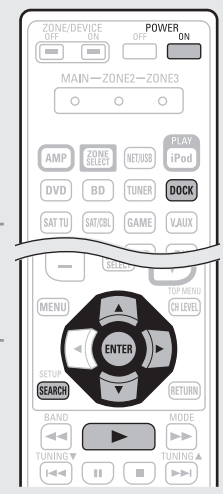



Playing an iPod®

□ iPod operation



Operation buttons	Function
<b>MENU</b>	Amp menu
△▽◀▶	Cursor operation
<b>ENTER</b>	Enter setting
<b>SEARCH</b> (Press and release)	Page search mode * 1
<b>SEARCH</b> (Press and hold)	Browse / Remote mode switching
<b>RETURN</b>	Return
◀▶	Manual search (fast-reverse/fast-forward)
▶	Playback / Pause
◀▶▶▶	Auto search (cue)
⏸	Pause
■	Stop
<b>RESTORER</b>	RESTORER
<b>MEMORY</b>	Store memory * 2
<b>TV POWER</b>	TV power on/standby (Default : SONY)
<b>TV INPUT</b>	Switch TV input (Default : SONY)

• Repeat playback (☞ page 46 "Repeat")

• Shuffling playback (☞ page 46 "Shuffle")

\* 1 This functions when an ASD-1R or ASD-11R is used.

\* 2 This functions when an ASD-3N, ASD-3W, ASD-51N or ASD-51W is used.



• The time (default: 30 sec) for which the on-screen display are displayed can be set at menu "iPod" (☞ page 57). Press △▽◀▶ to return to the original screen.

• To play back compressed audio with extended bass or treble reproduction, we recommend playback in RESTORER mode (☞ page 51). The default setting is "Mode 3".

• In Browse mode, press **STATUS** during playback to check the title name, artist name, and album name.

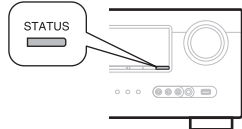

**NOTE**

• Press **POWER OFF** and set this unit's power to the standby mode before disconnecting the iPod. Also switch the input source to "DOCK" before disconnecting the iPod.

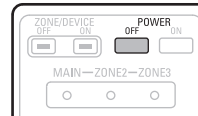

• Depending on the type of iPod and the software version, some functions may not operate.  
• Note that DENON will accept no responsibility whatsoever for any problems arising with the data on an iPod when using this unit in conjunction with the iPod.

□ Viewing videos on an iPod® in the Browse mode

When an iPod equipped with a video function is connected to a DENON ASD-11R, ASD-3N, ASD-3W, ASD-51N and ASD-51W control dock for iPod, image files can be played in the Browse mode.

**1** Use △▽ to select "Videos", then press **ENTER** or ▶.

**2** Use △▽ to select the search item or folder, then press **ENTER** or ▶.

**3** Use △▽ to select the video file, then press **ENTER**, ▶ or ▶.

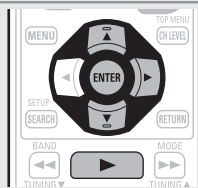

□ Viewing photos and videos on an iPod® in the Remote mode

This unit can play back on a TV screen photos and data stored on an iPod equipped with a slide show or video function.

**1** Press and hold **SEARCH** to set the Remote mode.  
"Remote iPod" or "Dock Remote" is displayed on the display of this unit.

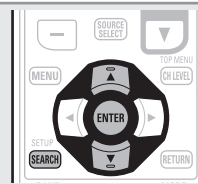

**2** Watching the iPod's screen, use △▽ to select "Photos" or "Videos".

• Depending on the iPod model, it may be necessary to operate the iPod unit directly.

**3** Press **ENTER** until the image you want to view is displayed.



"TV Out" at the iPod's "Slide show Settings" or "Video Settings" must be set to "On" in order to display the iPod's photo data or videos on the monitor. For details, see the iPod's operating instructions.

**NOTE**

Video may not be output, depending on the combination of ASD-1R, ASD-11R, ASD-3N, ASD-3W, ASD-51N or ASD-51W and iPod.

**② Connect the iPod directly to the USB port to play back**

You can use the USB cable provided with the iPod® to connect the iPod with the unit's USB port and enjoy music stored on the iPod.

• This unit supports audio playback from the iPod (fifth generation or later), iPod nano, iPod classic, iPod touch and iPhone (it is not compatible with iPod shuffle).

**1** Connect the iPod® to the USB port (☞ page 18 "Connecting an iPod or USB memory device to the USB Port").

**2** Press **POWER ON** to turn on power to the unit.

**3** Press **NET/USB** to switch the input source to "USB/iPod".

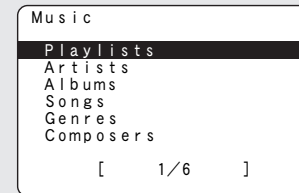

**NOTE**

If the connections screen is not displayed, the iPod may not be properly connected. Reconnect it.



#### 4 Press **SEARCH** and hold it down for 2 seconds or more to select the display mode.

- There are two modes for display the contents recorded on the iPod.

**Browse mode** Display iPod information on the TV screen.

- English letters, numbers and certain symbols are displayed. Incompatible characters are displayed as “.” (period).

**Remote mode** Display iPod information on the iPod screen.

- “Remote iPod” is displayed on the display of this unit.
- The Remote mode is not supported on fifth generation iPod or first generation iPod nano.

Display mode		Browse mode	Remote mode
Playable files	Music file	✓	✓
	Video file		*
Active buttons	Remote control unit (This unit)	✓	✓
	iPod®		✓

\* Only the sound is played.

#### 5 Use **△▽** to select the item, then press **ENTER** or **▷** to select the file to be played.

#### 6 Press **ENTER**, **▷** or **▶**. Playback starts.

### □ iPod operation



Operation buttons	Function
<b>MENU</b>	Amp menu
△▽◁▷	Cursor operation
<b>ENTER</b>	Enter setting
<b>SEARCH</b> (Press and release)	Page search mode
<b>SEARCH</b> (Press and hold)	Browse / Remote mode switching
<b>RETURN</b>	Return
◀▶▶▶	Manual search (fast-reverse/fast-forward)
▶	Playback / Pause
◀◀◀▶▶▶	Auto search (cue)
⏸	Pause
■	Stop
<b>RESTORER</b>	RESTORER
<b>TV POWER</b>	TV power on/standby (Default : SONY)
<b>TV INPUT</b>	Switch TV input (Default : SONY)

- **Repeat playback** (🔊 page 46 “Repeat”)
- **Shuffling playback** (🔊 page 46 “Shuffle”)



- The time (default: 30 sec) for which the on-screen display are displayed can be set at menu “iPod” (🔊 page 57). Press **△▽◁▷** to return to the original screen.
- To play back compressed audio with extended bass or treble reproduction, we recommend playback in RESTORER mode (🔊 page 51). The default setting is “Mode 3”.
- In Browse mode, press **STATUS** during playback to check the title name, artist name, and album name.

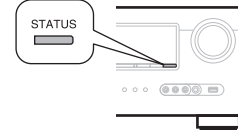

#### NOTE

- Depending on the type of iPod and the software version, some functions may not operate.
- Note that DENON will accept no responsibility whatsoever for any problems arising with the data on an iPod when using this unit in conjunction with the iPod.

### iPod play function

If **iPod PLAY** is pressed when power of this unit is on standby and a control dock for iPod or an iPod is connected, the iPod starts playback.

#### Press iPod PLAY.

- Power of this unit is turned on.
- This unit’s input source switches to “DOCK” or “USB/iPod”.
- iPod playback starts.

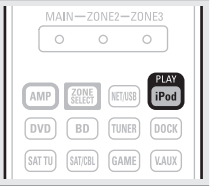

If **iPod PLAY** on the main unit is pressed, the same function as with the remote control unit can be obtained.



#### NOTE

- iPod play function does not function if a control dock for iPod (“DOCK”) or an iPod (“USB/iPod”) is not connected.
- If both a control dock for iPod (“DOCK”) and an iPod (“USB/iPod”) are priority connected, playback with control dock for iPod (“DOCK”) takes priority.

# Tuning in radio stations

## Listening to FM/AM broadcasts

**1** Press **TUNER** to switch the input source to “TUNER”.

**2** Press **BAND** to select “FM” or “AM”.

**FM** When listening to an FM broadcast.

**AM** When listening to an AM broadcast.

**3** Tune in the desired broadcast station.

**1** To tune in automatically (Auto tuning)

Press **MODE** to light the “AUTO” indicator on the display, then use **TUNING ▲** or **TUNING ▼** to select the station you want to hear.

**2** To tune in manually (Manual tuning)

Press **MODE** to turn off the display’s “AUTO” indicator, then use **TUNING ▲** or **TUNING ▼** to select the station you want to hear.

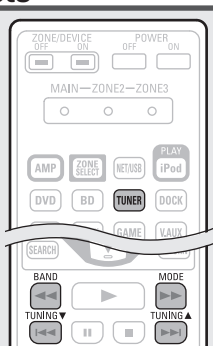

## Tuner (FM/AM) operation



Operation buttons	Function
<b>CH +, -</b>	Preset channel selection
<b>MENU</b>	Amp menu
<b>△▽◀▶</b>	Cursor operation
<b>ENTER</b>	Enter setting
<b>SEARCH</b>	Direct frequency tuning
<b>RETURN</b>	Return
<b>BAND</b>	FM/AM switching
<b>MODE</b>	Switch search modes
<b>TUNING ▲▼</b>	Tuning (up/down)
<b>0 - 9</b>	Preset channel selection (1 - 8) / Direct frequency tuning (0 - 9)
<b>SHIFT</b>	Preset channel block selection
<b>MEMORY</b>	Preset memory registration
<b>TV POWER</b>	TV power on/standby (Default : SONY)
<b>TV INPUT</b>	Switch TV input (Default : SONY)



- If the desired station cannot be tuned in with auto tuning, tune it manually.
- When tuning in stations manually, press and hold **TUNING ▲** or **TUNING ▼** to change frequencies continuously.
- The time (default : 30 sec) for which the on-screen display are displayed can be set at menu “TUNER” (page 57). Press **△▽◀▶** to return to the original screen.

## Presetting radio stations (Manual preset)

Your favorite broadcast stations can be preset so that you can tune them in easily. Up to 56 stations can be preset.

• Stations can be preset automatically at “Auto Preset” (page 43). If “Auto Preset” is performed after performing “Manual Preset”, the “Manual Preset” settings will be overwritten.

**1** Tune in the broadcast station you want to preset.

**2** Press **MEMORY**.

**3** Press **SHIFT** to select the block (A to G) in which the channel (1 to 8 per a block) is to be preset, then press **CH +, CH -** or **1 - 8** to select the preset number.

**4** Press **MEMORY** again to complete the setting.

• To preset other stations, repeat steps 1 to 4.



## Default settings

Block (A - G) and Channel (1 - 8)	Default Settings
A1 - A8	87.5 / 89.1 / 98.1 / 107.9 / 90.1 / 90.1 / 90.1 / 90.1 MHz
B1 - B8	520 / 600 / 1000 / 1400 / 1500 / 1710 kHz, 90.1 / 90.1 MHz
C1 - C8	90.1 MHz
D1 - D8	90.1 MHz
E1 - E8	90.1 MHz
F1 - F8	90.1 MHz
G1 - G8	90.1 MHz

**Specify a name for the preset broadcast station (Preset Name)** (page 44)

## Listening to preset stations

**1** Press **SHIFT** to select the memory block (A to G).

**2** Press **CH +, CH -** or **1 - 8** to select the desired preset channel.



You can also operate via the main unit. In this case, perform the following operations. Press **TUNING PRESET**, then turn **SOURCE SELECT** to select the preset radio station.

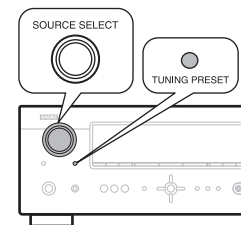

## Direct frequency tuning

You can enter the receiving frequency directly to tune in.

**1** Press **SEARCH**.

**2** Input frequencies using the **0 - 9**.

• If **<** is pressed, the immediately preceding input is cancelled.

**3** When setting is completed, press **ENTER**.

The preset frequency is tuned in.



# Playing a USB memory device

Playing back music files recorded on a USB memory device.

## Important information

### USB memory devices

- A USB memory device can be connected to the USB port of this unit to play music files stored on the USB memory device.
- Only USB memory devices conforming to mass storage class can be played on this unit.
  - This unit is compatible with USB memory devices in "FAT16" or "FAT32" format.

[Compatible formats]

	USB memory devices *1
<b>WMA</b> (Windows Media Audio)	✓*2
<b>MP3</b> (MPEG-1 Audio Layer-3)	✓
<b>MPEG-4 AAC</b>	✓*3

- \*1 USB
  - This unit is compatible with MP3 ID3-Tag (Ver. 2) standards.
  - This unit is compatible with WMA META tags.
- \*2 Copyright-protected files can not be played.
- \*3 Only files that are not protected by copyright can be played on this unit.
 

Also, files encoded in WMA format when ripped from a CD, etc. on a computer may be copyright protected, depending on the computer's settings.

[Compatible formats]

	Sampling frequency	Bit rate	Extension
<b>WMA</b> (Windows Media Audio)	32/44.1/48 kHz	48 – 192 kbps	.wma
<b>MP3</b> (MPEG-1 Audio Layer-3)	32/44.1/48 kHz	32 – 320 kbps	.mp3
<b>MPEG-4 AAC</b>	32/44.1/48 kHz	16 – 320 kbps	.m4a

## Playing files stored on USB memory devices

- 1 Connect the USB memory device to the USB port (☞ page 18 "Connecting an iPod or USB memory device to the USB Port").
- 2 Press **NET/USB** to switch the input source to "USB/iPod".
- 3 Press  $\Delta \nabla$  to select the search item or folder, then press **ENTER** or  $\triangleright$ .
- 4 Press  $\Delta \nabla$  to select the file, then press **ENTER**,  $\triangleright$  or  $\blacktriangleright$ . Playback starts.



### USB operation



Operation buttons	Function
<b>MENU</b>	Amp menu
$\Delta \nabla \triangleleft \triangleright$	Cursor operation
<b>ENTER</b>	Enter setting
<b>SEARCH</b>	Page Search
<b>RETURN</b>	Return
$\lll \ggg$ (Press and hold)	Manual search (fast-reverse/fast-forward)
$\triangleright$	Playback
$\lll \triangleright \ggg$	Auto search (cue)
$\parallel$	Pause
$\blacksquare$	Stop
<b>RESTORER</b>	RESTORER
<b>TV POWER</b>	TV power on/standby (Default : SONY)
<b>TV INPUT</b>	Switch TV input (Default : SONY)

- Repeat playback (☞ page 46 "Repeat")
- Shuffling playback (☞ page 46 "Shuffle")



- The time (default: 30 sec) for which the on-screen display are displayed can be set at menu "USB" (☞ page 57). Press  $\Delta \nabla \triangleleft \triangleright$  to return to the original screen.
- To play back compressed audio with extended bass or treble reproduction, we recommend playback in RESTORER mode (☞ page 51). The default setting is "Mode 3".
- If the USB memory device is divided into multiple partitions, only the top partition can be selected.
- This unit is compatible with MP3 files conforming to "MPEG-1 Audio Layer-3" standards.

### NOTE

- Note that DENON will accept no responsibility whatsoever for any problems arising with the data on a USB memory device when using this unit in conjunction with the USB memory device.
- USB memory devices will not work via a USB hub.
- DENON does not guarantee that all USB memory devices will operate or be supplied power. When using a USB portable hard disk that can draw power from an AC adapter, we recommend using the AC adapter.
- It is not possible to connect and use a computer via the USB port of this unit using a USB cable.

# Selecting a listening mode (Surround mode)

This unit can play input audio signals in multi-channel surround mode or in stereo mode.  
Select a listening mode suitable for the playback contents (cinema, music, etc.) or according to your liking.

## Listening Mode

Input audio signal	Playback	Listening mode	
2-channel Multi channel	⇒ Surround ⇒	Standard playback (page 26)	<p>For 2-channel signal input:</p> <ul style="list-style-type: none"> <li>Surround-channel signals are created and played with surround playback.</li> </ul> <p>For multichannel signal input:</p> <ul style="list-style-type: none"> <li>The surround signal recorded in source is played as surround playback. (The sound is played according to the settings of the speaker size in "Speaker Config." (page 52).)</li> <li>Surround-back-channel or front-height-channel signals that are not recorded in source can be created.</li> </ul>
2-channel Multi channel	⇒ Surround ⇒	DENON original surround playback (page 28)	<p>The surround effects suitable for the source type or according to your liking can be selected from the DENON original sound mode and is used for playback.</p>
2-channel Multi channel	⇒ Stereo ⇒	Stereo playback (page 28)	<ul style="list-style-type: none"> <li>If multichannel signals are input, they are mixed down to 2-channel audio and are played.</li> <li>Subwoofer signals are also output.</li> </ul>
2-channel Multi channel	⇒ Stereo ⇒ ⇒ Surround ⇒	Direct playback (page 28)	<p>Sound recorded in source is played as is.</p> <ul style="list-style-type: none"> <li>Surround back signals or front height signals are not created.</li> <li>In this mode, the following items cannot be adjusted.                             <ul style="list-style-type: none"> <li>Tone (page 49)</li> <li>MultEQ® (page 49)</li> <li>Dynamic EQ® (page 50)</li> <li>Dynamic Volume™ (page 50)</li> <li>RESTORER (page 51)</li> </ul> </li> </ul> <p> If a "Small" speaker is used, playback in "Standard playback" mode is recommended.</p>
2-channel Multi channel	⇒ Stereo ⇒ ⇒ Surround ⇒	Pure direct playback (page 28)	<p>This mode is for playback in higher sound quality than in "Direct playback" mode. The following circuits that affect sound quality are set to off.</p> <ul style="list-style-type: none"> <li>Main unit's display circuit (The display is turned off.)</li> <li>Analog video input/output circuit</li> </ul>



- Some listening modes cannot be selected, depending on the audio format or number of channels of the input signal. For details, see "Types of input signals, and corresponding surround modes" (page 72).
- Adjust the sound field effect with the menu "Surround Parameter" (page 47) to enjoy your favorite sound mode.
- You can select the listening mode by pressing **SURROUND MODE** ◀ or **SURROUND MODE** ▶ on the main unit. Press **SURROUND MODE** ◀ or **SURROUND MODE** ▶ and the modes are switched as shown below.

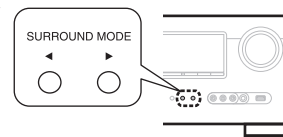

## Standard playback

### Surround playback of 2-channel sources

- Playing the source (page 21 – 25).
- Press **STANDARD** to select the surround decoder to play back multichannel sound.



- Each time **STANDARD** is pressed, the surround mode is switched. Which decoder can be selected depends on the settings of "Amp Assign" (page 52) or "Speaker Config." (page 52).

**DOLBY PLIIz** \*1 This mode is for 7.1-channel surround playback using the front height speakers.  
• "PLIIz Height" is displayed.

**DOLBY PLIIx** \*2 This mode is for 7.1-channel or 6.1-channel surround playback using the surround back speakers.  
• "PLIIx Cinema", "PLIIx Music" or "PLIIx Game" is displayed.

**DOLBY PLII** This mode is for 5.1-channel surround playback. Select this mode if no front height speaker nor surround back speaker is to be used.  
• "PLII Cinema", "PLII Music", "PLII Game" or "Pro Logic" is displayed.

**DTS NEO:6** This mode is for 7.1-channel, 6.1-channel or 5.1-channel surround playback using the surround back speakers.  
• "DTS NEO:6 Cinema" or "DTS NEO:6 Music" is displayed.

\*1 This can be selected when "Amp Assign" is set to "Front Height" or "Speaker Config." – "Front Height" is not set to "None".

\*2 This can be selected when "Amp Assign" is set to "Normal" or "Speaker Config." – "S.Back" is not set to "None".

**3** Select the mode corresponding to the playback contents with the menu “Surround Parameter” – “Mode” (☞ page 47) to enjoy your favorite sound mode.

- Cinema** This mode is suited for movie sources.
  - Music** This mode is suited for music sources. More sound is sent to the front speakers than in “Cinema” mode.
  - Game** This mode is suited for games.
  - Pro Logic** This mode is suitable for playback of 2-channel sources recorded with Dolby Pro Logic.
  - Height** \* This mode is for the surround decoder “Dolby PLIIz”. If the surround decoder is “Dolby PLIIz”, another mode cannot be selected.
- If the menu “Surround Parameter” – “Front Height” (☞ page 48) is set to “ON”, the mode is switched to “Height” mode.

**Surround playback of multi-channel sources (Dolby Digital, DTS etc.)**

- 1** Playing the source (☞ page 21 – 25).
- 2** Press **STANDARD** to select the surround decoder to play back multichannel sound.



Select the surround mode while viewing the display on the screen (☞ “Displaying The Currently Playing Surround Mode” at right).

• Which decoder can be selected depends on the input signal, the settings of “Amp Assign” (☞ page 52) or “Speaker Config.” (☞ page 52).

**Displaying the currently playing surround mode**

Input signal	Surround mode	Display
DOLBY DIGITAL (other than 2ch) / DOLBY DIGITAL EX	DOLBY DIGITAL	DOLBY DIGITAL
	DOLBY DIGITAL EX	DOLBY DIGITAL EX
	DOLBY DIGITAL + PLIIx CINEMA	DOLBY D + PLIIx C
	DOLBY DIGITAL + PLIIx MUSIC	DOLBY D + PLIIx M
	DOLBY DIGITAL + PLIIz HEIGHT	DOLBY D + PLIIz
DOLBY DIGITAL Plus	DOLBY DIGITAL Plus	DOLBY DIGITAL +
	DOLBY DIGITAL Plus + EX	DOLBY D + + EX
	DOLBY DIGITAL Plus + PLIIx CINEMA	DOLBY D + + PLIIx C
	DOLBY DIGITAL Plus + PLIIx MUSIC	DOLBY D + + PLIIx M
	DOLBY DIGITAL Plus + PLIIz HEIGHT	DOLBY D + + PLIIz
DOLBY TrueHD	DOLBY TrueHD	DOLBY TrueHD
	DOLBY TrueHD + EX	DOLBY HD +EX
	DOLBY TrueHD + PLIIx CINEMA	DOLBY HD +PLIIx C
	DOLBY TrueHD + PLIIx MUSIC	DOLBY HD +PLIIx M
	DOLBY TrueHD + PLIIz HEIGHT	DOLBY HD +PLIIz
DTS (5.1ch) / DTS-ES Discrete 6.1 / DTS-ES Matrix 6.1 / DTS 96/24	DTS SURROUND	DTS SURROUND
	DTS + PLIIx CINEMA	DTS + PLIIx C
	DTS + PLIIx MUSIC	DTS + PLIIx M
	DTS + PLIIz HEIGHT	DTS + PLIIz
	DTS + NEO:6	DTS + NEO:6
	DTS ES MTRX6.1*1	DTS ES MTRX6.1
	DTS ES DSCRT6.1*2	DTS ES DSCRT6.1
	DTS 96/24*3	DTS 96/24
DTS-HD	DTS-HD HI RES	DTS-HD HI RES
	DTS-HD MSTR	DTS-HD MSTR
	DTS-HD + NEO:6	DTS-HD + NEO:6
	DTS-HD + PLIIx CINEMA	DTS-HD + PLIIx C
	DTS-HD + PLIIx MUSIC	DTS-HD + PLIIx M
	DTS-HD + PLIIz HEIGHT	DTS-HD + PLIIz
	DTS Express	DTS Express
PCM (multi ch)	MULTI CH IN	MULTI CH IN
	MULTI IN + Dolby EX	MULTI +Dolby EX
	MULTI IN + PLIIx CINEMA	MULTI IN +PLIIx C
	MULTI IN + PLIIx MUSIC	MULTI IN +PLIIx M
	MULTI IN + PLIIz HEIGHT	MULTI IN +PLIIz
	MULTI CH IN 7.1	MULTI CH IN 7.1

\*1 This is displayed when the input signal is “DTS-ES Matrix 6.1” and this unit’s “AFDM” (☞ page 48) setting is “ON”.

\*2 This is displayed when the input signal is “DTS-ES Discrete 6.1”.

\*3 This is displayed when the input signal is “DTS 96/24”.

**[Views on the display]**

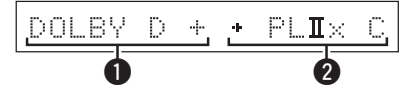

- 1** Shows a decoder to be used.
  - A DOLBY DIGITAL Plus decoder is displayed as “DOLBY D +”.
- 2** Shows a decoder that creates sound output from the surround back speakers.
  - “+ PLIIz” indicates the front height sound from front height speakers.



For an input signal that can be reproduced in each surround mode, see “Surround modes and surround parameters” (☞ page 70).

Simple version

Basic version

Advanced version

Information

## DENON original surround playback

**1** Playing the source (👉 page 21–25).

**2** Press **SIMULATION** to select the surround mode.

- Each time **SIMULATION** is pressed, the surround mode is switched.



### MULTI CH STEREO

This mode is for enjoying stereo sound from all speakers.

### ROCK ARENA

This mode is for enjoying the atmosphere of a live concert in an arena.

### JAZZ CLUB

This mode is for enjoying the atmosphere of a live concert in a jazz club.

### MONO MOVIE \*

This mode is for playing monaural movie sources with surround sound.

### VIDEO GAME

This mode is suited for achieving surround sound with video games.

### MATRIX

This mode lets you add a spacious feel to stereo music sources.

### VIRTUAL

This mode is for enjoying surround effects using only the front speakers or headphones.

- \* When playing sources recorded in monaural in the “MONO MOVIE” mode, the sound will be off balance with a single channel (left or right), so input to both channels.



Depending on the program source being played, it may not be possible to achieve a satisfactory surround effect. In this case, try other modes to achieve a sound field suited to your tastes.

### NOTE

When the input signal is Dolby TrueHD, Dolby Digital Plus, DTS-HD or DTS Express, you cannot select DENON original surround mode.

## Stereo playback

**1** Playing the source (👉 page 21 – 25).

**2** Press **D/ST** to select “STEREO”. Stereo playback begins.



## Direct playback

**1** Playing the source (👉 page 21 – 25).

**2** Press **D/ST** to select “DIRECT”. Direct playback begins.

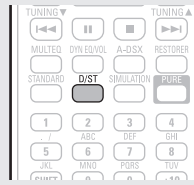

## Pure direct playback

**1** Playing the source (👉 page 21 – 25).

**2** Press **PURE**. The display goes dark, and pure direct playback begins.



- To cancel, press **PURE** again.
- Video signals are only output when HDMI signals are played in the PURE DIRECT mode.





### NOTE

When in the PURE DIRECT mode, the menu screen is not displayed.

## Advanced version

---

Here, we explain functions and operations that let you make better use of this unit.

- **Speaker installation/connection (Other than 5.1-channel)**  **page 30**
- **Playback (Advanced operation)**  **page 34**
- **Playback in ZONE2 (Separate room)**  **page 37**
- **How to make detailed settings**  **page 39**
- **Operating the connected devices by remote control unit**  **page 60**



# Speaker installation/connection (Other than 5.1-channel)

Here we describe the installation, connection and setup methods for speakers other than 5.1-channel speakers. For the installation, connection and setup methods for 5.1-channel speakers, see "Simple version (Simple setup guide)" (page 3).

## Procedure for speaker settings

Install

Connect (page 31)

Set up speakers (page 33)

## Install

This unit is compatible with Dolby Pro Logic IIz (page 74), which offers an even wider and deeper surround sensation. When using Dolby Pro Logic IIz, install front height speakers.



Install the surround back speakers in a position 2 to 3 ft (60 to 90 cm) higher than ear level.

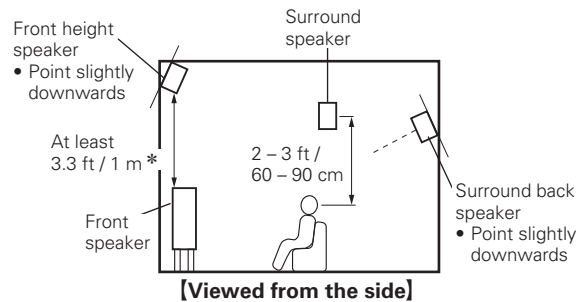

\* Recommended for Dolby Pro Logic IIz

### NOTE

It is not possible to use the surround back speakers and front height speakers simultaneously.

### When 7.1ch (Front height speaker) installed

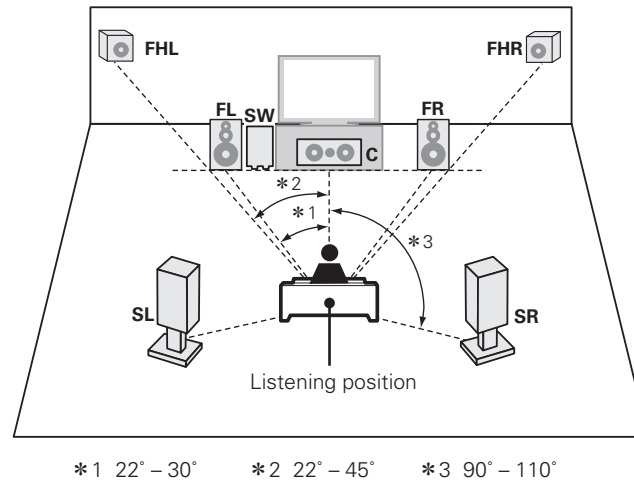

### When 6.1ch (Surround back speaker) installed

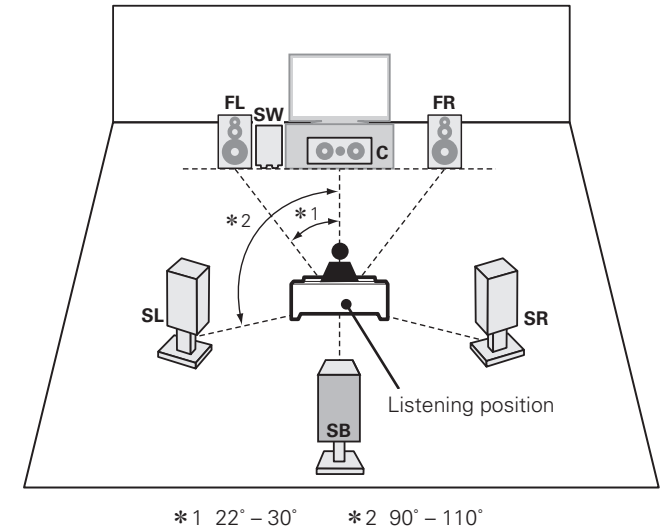

### When 7.1ch (Surround back speaker) installed

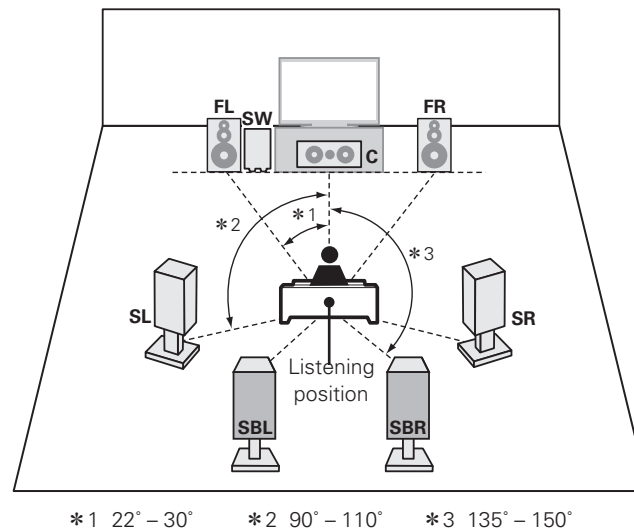

### When Front A/B speakers installed

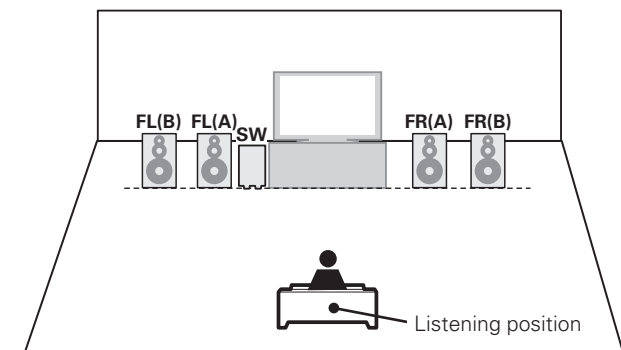

- FL Front speaker (L)
- FR Front speaker (R)
- C Center speaker
- SW Subwoofer
- SL Surround speaker (L)
- SR Surround speaker (R)

- SBL Surround back speaker (L)
- SBR Surround back speaker (R)
- FHL Front height speaker (L)
- FHR Front height speaker (R)

## Connect

- For the method of connecting 5.1-channel speakers, see page 4.
- For the method of connecting the TV, see page 5.

### 7.1-channel (Front height speaker) connection

For 7.1-channel (Front height speaker) playback, set "Amp Assign" in "Set up speakers" (page 33) to "Front Height".

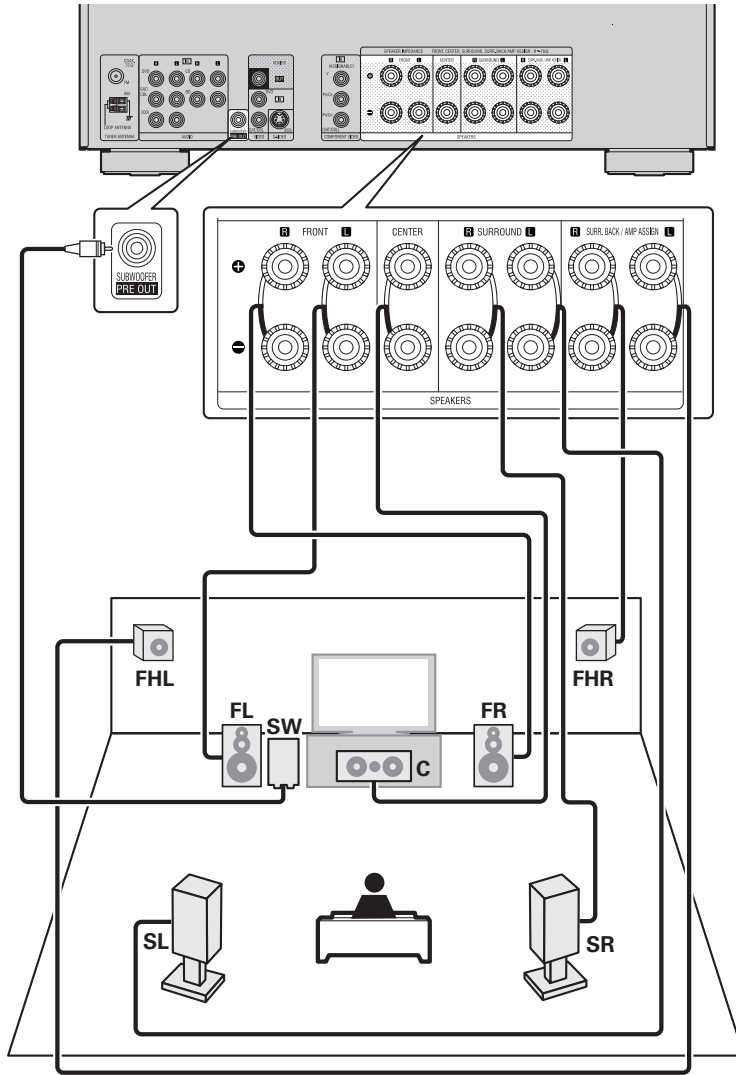

### 7.1-channel/6.1-channel (Surround back speaker) connection

For 7.1-channel (Surround back speaker) playback, set "Amp Assign" in "Set up speakers" (page 33) to "Normal".

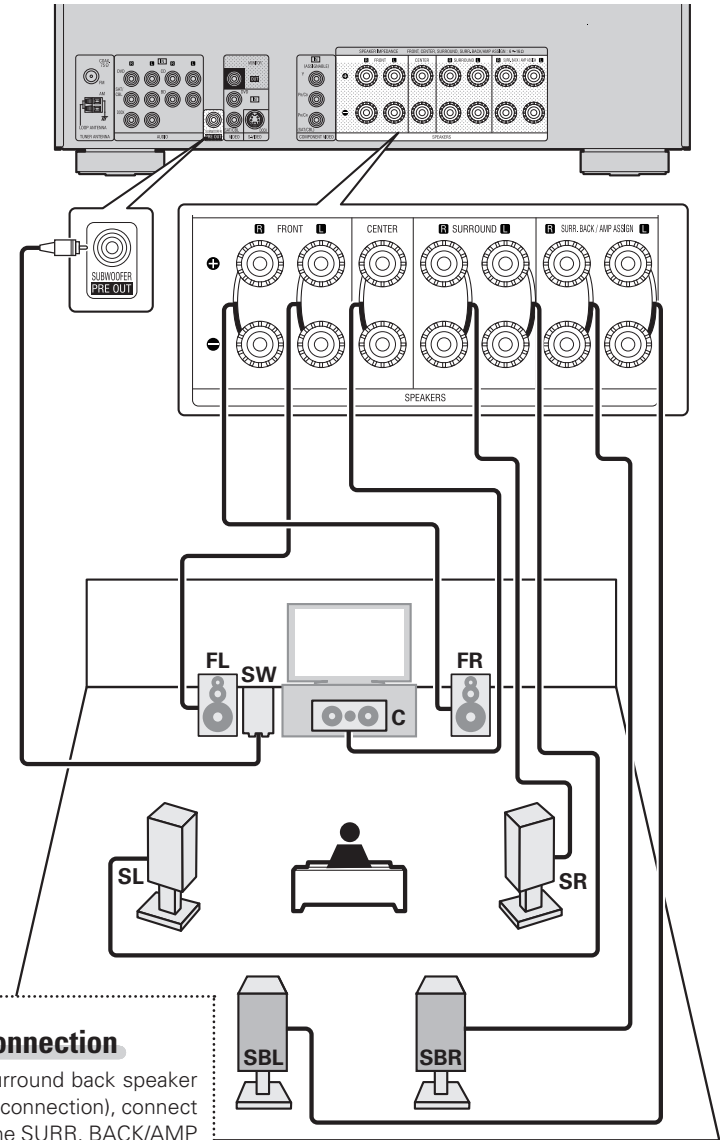

#### 6.1-channel connection

If using just one surround back speaker (with a 6.1-channel connection), connect to the "L" side of the SURR. BACK/AMP ASSIGN terminal.

For speaker settings in this case, see "When 6.1ch (Surround back speaker) installed" (page 30).

For speaker impedance and speaker cable connections, see page 4.

Connect

**Front A/B connection**

The second set of front speakers can be connected to the SURR. BACK/AMP ASSIGN terminals. In this case, set "Amp Assign" of "Set up speakers" (page 33) to "Front B".

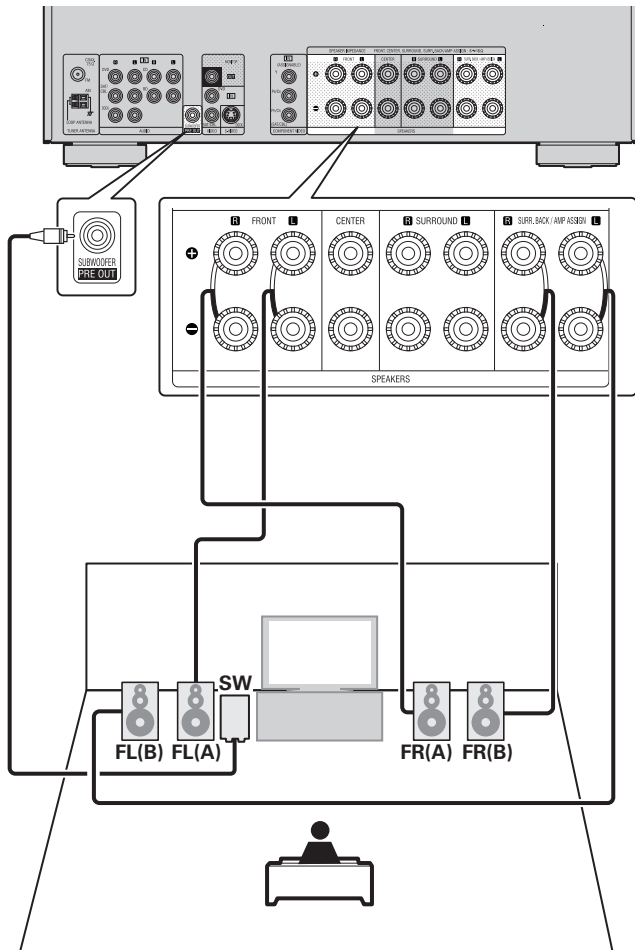

For surround playback of a multichannel source, if you connect the center speaker, surround speakers and subwoofers, 5.1-channel playback is available.

Front speakers can be used separately, depending on the speaker's specifications or playback source such as front speakers (A) for multichannel playback and front speakers (B) for 2-channel playback (page 54 "Front Speaker Setup").

**2.1-channel/2-channel connection**

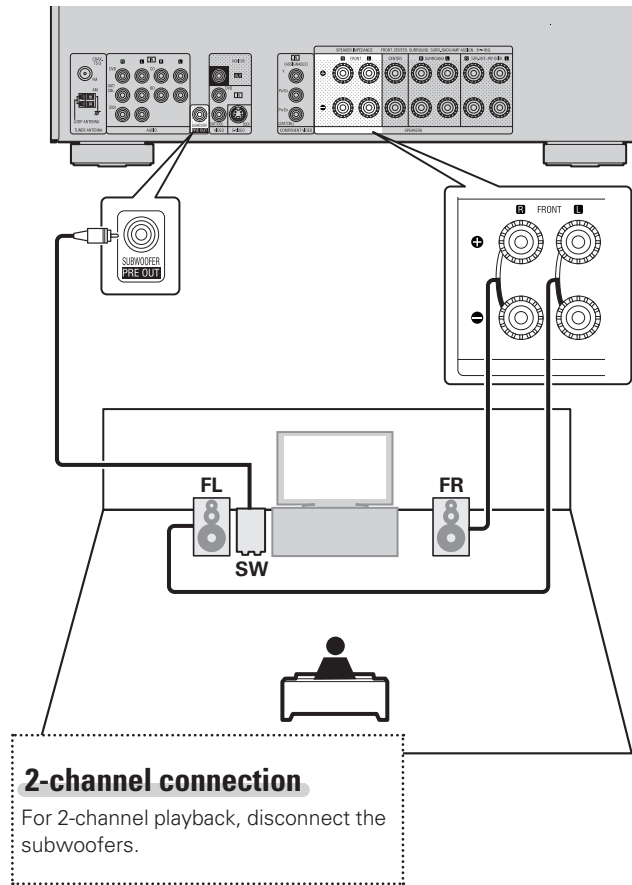

**2-channel connection**

For 2-channel playback, disconnect the subwoofers.

**Bi-amp connection**

A bi-amp connection is to connect separate amplifiers to the tweeter terminals and woofer terminals of speakers compatible with the bi-amp function. This prevents the back electromotive force (returned force without output) of the woofer sent to the tweeter, which affects the sound quality of the tweeter, and you can enjoy playback with higher-quality sound.

In this case, set "Amp Assign" of "Set up speakers" (page 33) to "Front Bi-Amp".

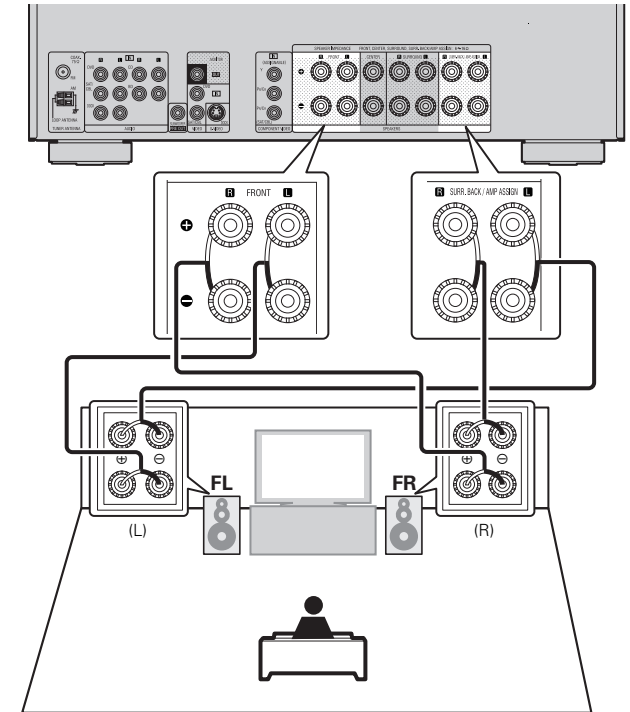

When making a bi-amp connection, the same signal is output from the front speaker terminal and the SURR. BACK/AMP ASSIGN terminal. For surround playback of a multichannel source, if you connect the center speaker, surround speakers and subwoofers, 5.1-channel playback is available.

**NOTE**

- Use speakers compatible with bi-amp connections.
- When making bi-amp connections, be sure to remove the short-circuiting plate or wire between the speaker's woofer and tweeter terminals.

# Set up speakers

around items indicate the settings.

Here we describe how to set up speakers other than 5.1-channel speakers.

For the method of setting up 5.1-channel speakers, see "Simple version", "Set up speakers (Audyssey® Auto Setup)" (page 6).

First install and connect the speakers to this unit.

**1 Set up the remote control unit**

**Set up the zone mode**  
Press **ZONE SELECT** to switch the zone mode to "MAIN".  
The "MAIN" indicator lights.

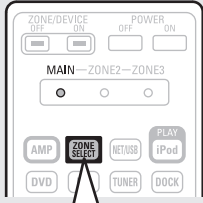

**Press ZONE SELECT**

**Set up the operation mode**  
Press **AMP** to set the remote control unit to amplifier operation mode.

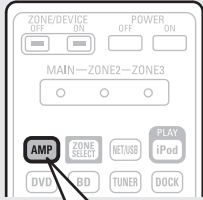

**Press AMP**

**2 Connect the setup microphone.**

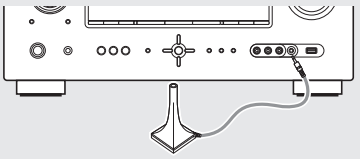

When the setup microphone is connected, the following screen is displayed.

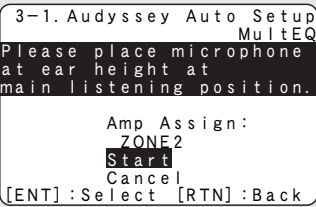

**3 Use  $\Delta$ / $\nabla$  to select "Amp Assign".**

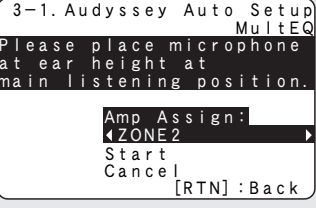

**4 Use  $\triangleleft$ / $\triangleright$  to select the configuration of the connected speakers.**

- Normal** Set when using 7.1-channel (Front/Center/Surround/Surround Back/Subwoofer) speakers.
- ZONE2** Set for connecting the speakers for ZONE2 to the SURR. BACK/AMP ASSIGN terminals.
- Front Height** Set for connecting the front height speakers to the SURR. BACK/AMP ASSIGN terminals.
- Front Bi-Amp** Set for connecting a tweeter of a front speaker to the SURR. BACK/AMP ASSIGN terminals and a woofer of the front speaker to the FRONT terminals.
- Front B** Set for connecting the second set of front speakers to the SURR. BACK/AMP ASSIGN terminals. In this case, go to step 6.

**5 [When "Front B" is selected in step 4]**

- ① Use  $\Delta$ / $\nabla$  to select "Front Sp."
- ② Press  $\triangleleft$ / $\triangleright$  to select a speaker.

- A** Select this to use front speaker A.
- B** Select this to use front speaker B.
- A+B** Select this to use front speakers A and B simultaneously.

**6 Proceed to page 8 "Preparation" step 5.**

**NOTE**  
After performing Audyssey Auto Setup, do not change the speaker connections or subwoofer volume. In event of a change, perform Audyssey Auto Setup again.

Simple version

Basic version

Advanced version

Information

# Playback (Advanced operation)

**Playback (Basic operation)** (👉 page 20)

**Selecting a listening mode (Surround mode)**  
(👉 page 26)

- HDMI control function** (👉 page 34)
- Sleep timer function** (👉 page 35)
- Adjusting the volume of the speakers** (👉 page 35)
- Quick select function** (👉 page 36)
- Various memory functions** (👉 page 36)

## Convenient functions

### HDMI control function

When you make an HDMI connection with a TV or player compatible with this unit and HDMI control functions, you can perform the following operations by setting the HDMI control function of each device.

- This unit power off can be linked to the TV power off step.**
- You can switch audio output devices with a TV operation.**  
When you set "Output audio from amp" in the TV audio output setup operation, you can switch the amp power on.
- You can adjust this unit volume in the TV volume adjustment operation.**
- You can switch this unit input sources through linkage to TV input switching.**
- When playing the player, this unit input source switches to the source for that player.**

#### NOTE

- **When "HDMI Control" is set to "ON", it consumes more standby power.**
- The HDMI control function controls operations of a TV that is compatible with the HDMI control function. Make sure that the TV and HDMI are connected when you perform HDMI control.
- Some functions may not operate depending on the connected TV or player. Check the owner's manual of each device for details beforehand.
- When "Power Off Control" on the menu is set to "OFF" (👉 page 55), this unit is not set to standby even if the connected device is in the standby mode.
- When connection changes are implemented, such as adding connections to HDMI devices, linked operations may be initialized. In this case, you will need to reconfigure the settings.
- When "HDMI Control" is set to "ON", it is not possible to assign an HDMI connector to "TV" at "Input Assign" (👉 page 44).

**1 Set the HDMI output connector corresponding with the HDMI control function.**

Set "HDMI Control" (👉 page 55) to "ON".

**2 Turn the power on for all the equipment connected by HDMI cable.**

**3 Set the HDMI control function for all equipment connected by HDMI cable.**

- Please consult the operating instructions for the connected equipment to check the settings.
- Carry out steps 1 and 2 should any of the equipment be unplugged.

**4 Switch the television input to the HDMI input connected to this unit.**

**5 Switch this unit input to the HDMI input source and check if the picture from the player is ok.**

**6 When you turn the TV's power to standby, check that the power of this unit also goes to standby.**



If the HDMI control function does not operate properly, check the following points.

- Is the TV or player compatible with the HDMI control function?
- Is "HDMI Control" (👉 page 55) set to "ON"?
- Is "Power Off Control" (👉 page 55) set to "All" or "Video"?
- Are the HDMI control function settings of all equipment correct?

#### NOTE

Should any of the operations below be performed, the interlocking function may be reset, in which case, repeat steps 2 and 3.

- "Input Assign" – "HDMI" (👉 page 44) setting has changed.
- There is a change to the connection between the equipment and the HDMI, or an increase in equipment.

## Sleep timer function

The power automatically goes into standby once the set time has elapsed.

This is convenient for playing sources while going to sleep.

Press **SLEEP** and display the time you want to set.

The "SLEEP" indicator on the display lights.

- The time switches as shown below each time **SLEEP** is pressed.

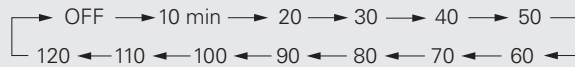

## To cancel the sleep timer

Press **SLEEP** to set "OFF".

The "SLEEP" indicator on the display turns off.



- The sleep timer setting is canceled if this unit's power is set to standby or turned off.
- When power to the main zone is turned off with the sleep timer, power in ZONE2 is also turned off.
- If **SLEEP** on the main unit is pressed, the same function as with the remote control unit can be obtained.

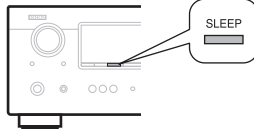

## Adjusting the volume of the speakers

You can adjust the channel level either according to the playback sources or to suit your taste, as described below.

### Adjusting the volume of the different speakers

**1** Press **ZONE SELECT** to switch the zone mode to "MAIN".  
The "MAIN" indicator lights.

**2** Press **AMP** to set the remote control unit to amplifier operation mode.

**3** Press **CH LEVEL**.

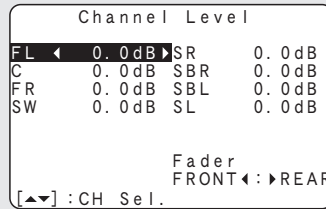

**4** Use **Δ**/**∇** to select the speaker.  
The speaker that can be set switches each time one of the buttons is pressed.

**5** Use **◀**/**▶** to adjust the volume.

- In the case of a subwoofer, pressing **◀** when it is at "-12 dB" will change the setting to "OFF".



When a headphone jack is inserted, the headphone channel level can be adjusted.



### Adjusting the volume of groups of speakers (Fader function)

This function lets you adjust (fade) the sound all at once from the front (front speaker / front height speaker / center speaker) or rear (surround speaker / surround back speaker).

**1** Press **ZONE SELECT** to switch the zone mode to "MAIN".  
The "MAIN" indicator lights.

**2** Press **AMP** to set the remote control unit to amplifier operation mode.

**3** Press **CH LEVEL**.

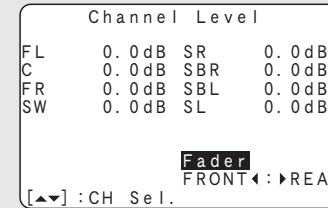

**4** Use **∇** to select "Fader", then select the item to be adjusting using **◀**/**▶**.

**5** Use **◀**/**▶** to adjust the volume of the speakers.  
(**◀**: front, **▶**: rear)



- The fader function does not affect the subwoofer.
- The fader can be adjusted until the volume of the speaker adjusted to the lowest value is -12 dB.



## Convenient functions

## Quick select function

All of the settings in step 1 can be memorized together. By memorizing frequently used settings, you can quickly access and enjoy a playback environment that is consistently the same.

### □ Saving the settings

#### 1 Set the items below to the settings you want to save.

- ① Input source (☞ page 20)
- ② Volume (☞ page 20)
- ③ Surround mode (☞ page 26)
- ④ Video Select (☞ page 45)
- ⑤ Audyssey Setting (MultEQ®, Dynamic EQ®, Dynamic Volume™) (☞ page 49)



#### 2 Press and hold the desired QUICK SELECT until “Memory” appears on the display.

The current settings will be memorized.

#### [Quick Select Defaults]

	Input Source	Volume
QUICK SELECT 1	BD	-40 dB
QUICK SELECT 2	SAT/CBL	-40 dB
QUICK SELECT 3	DOCK	-40 dB

### □ Recalling the settings

Press **QUICK SELECT** at which the settings you want to call out are saved.

The [Q1], [Q2] or [Q3] indicator illuminates on the display.

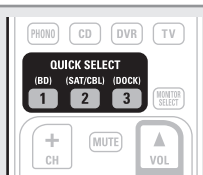

### Naming quick select settings

See “Quick Select Name” (☞ page 57).



- The Quick Select function can be set separately for the different zones (☞ page 38 “Quick select function”).
- If **QUICK SELECT** on the main unit is pressed, the same function as with the remote control unit can be obtained.

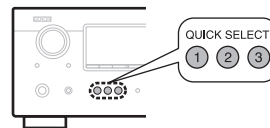

### NOTE

Input sources stored with the quick select function cannot be selected if they have been deleted at “Source Delete” (☞ page 57). In this case, store them again.

## Various memory functions

### □ Personal memory plus function

This function sets the settings (input mode, surround mode, HDMI output mode, MultEQ, Dynamic EQ, Dynamic Volume, audio delay etc.) last selected for the individual input sources.



The surround parameters, tone settings and the volumes of the different speakers are stored for the individual surround modes.

### □ Last function memory

This function stores the settings which were made before going into the standby mode.

When the power is turned back on, the settings are restored.

# Playback in ZONE2 (Separate room)

- You can operate this unit so as to enjoy audio in a room (ZONE2) other than the MAIN ZONE (room where the unit is located).
- You can simultaneously play back the same source in both the MAIN ZONE and ZONE2. You can also play back separate sources in the MAIN ZONE and ZONE2.

## Audio output

### ZONE2 playback by speaker output

The ZONE2 audio signals are output from this unit's SURR. BACK/AMP ASSIGN speaker terminals using the amplifier assignment function.

#### Connecting and setting the speakers

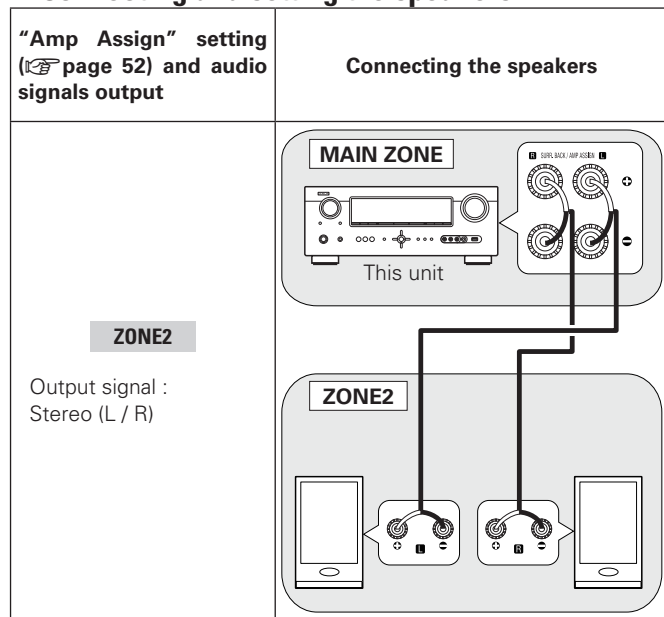

We recommend using high quality pin-plug cables for audio connections in order to prevent noise.

#### NOTE

It is not possible to play the digital audio signals input from the HDMI, COAXIAL or OPTICAL connectors in ZONE2.

## Playback

**1 Switch ZONE SELECT to "ZONE2".**  
The remote control unit switches to the operating mode for ZONE2.

**2 Press AMP.**

**3 Press ZONE/DEVICE ON to turn on the ZONE2 power.**  
The **Z2** indicator on the display lights.

- Also press input source select button when in standby mode, the power turns on.
- When **ZONE/DEVICE OFF** is pressed, ZONE2 turns off.
- Power in ZONE2 can be turned on or off by pressing **ZONE2 ON/OFF** on the main unit.

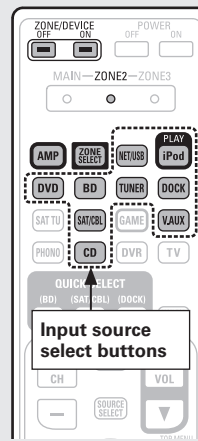

**4 Press the input source select button.**  
The audio signal of the selected source is output to ZONE2.

- Turn **SOURCE SELECT** after pressing **ZONE2 SELECT** on the main unit to select an input source.

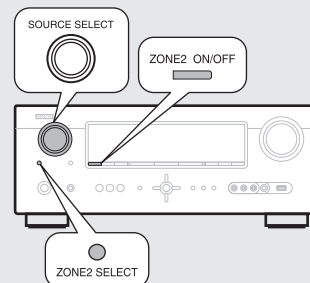

When power for both MAIN ZONE and ZONE2 is set to ON, power of the MAIN ZONE only can be turned off. Select "MAIN" in step 1 then press **ZONE/DEVICE OFF**.

## Adjust the volume

Use **VOL ▲▼** to adjust the volume.

**[Adjustable range]** --- **-80dB - -40dB - 18dB**  
(When the "Volume Display" (page 57) setting is "Relative")

**[Adjustable range]** **0 - 41 - 99**  
(When the "Volume Display" (page 57) setting is "Absolute")

- At time of purchase, "Volume Limit" (page 56) is set to "-10dB (71)".



Turn **MASTER VOLUME** after pressing **ZONE2 SELECT** on the main unit to adjust the sound volume.

## Turning off the sound temporarily

Press **MUTE**.

The sound is reduced to the level set at "Mute Level" (page 56) in the menu.

- To cancel, either adjust the volume or press **MUTE** again.
- The setting is canceled when the zone's power is turned off.



## Quick select function

It is also possible to save three settings for ZONE2.

### □ Saving the settings

#### 1 Set the items below to the settings you want to save.

- ① Input source (☞ page 37)
- ② Volume (☞ page 37)

#### 2 Switch **ZONE SELECT** to “ZONE2”.

The remote control unit switches to the operating mode for ZONE2.

#### 3 Press and hold the desired **QUICK SELECT** button until “Memory” appears on the display.

The current settings will be memorized.



#### [Quick select defaults]

	Input Source	Volume
QUICK SELECT 1	BD	-40dB
QUICK SELECT 2	SAT/CBL	-40dB
QUICK SELECT 3	DOCK	-40dB

### □ Recalling the settings

#### 1 Switch **ZONE SELECT** to “ZONE2”.

The remote control unit switches to the operating mode for ZONE2.

#### 2 Press **QUICK SELECT** at which the settings you want to call out are saved.

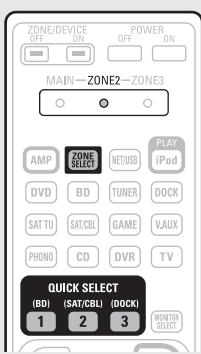

### Naming quick select settings

See “Quick Select Name” (☞ page 57).

# How to make detailed settings

## Menu map

For menu operation, connect a TV to this unit and display the menu on the TV screen. For menu operations, see the following page.

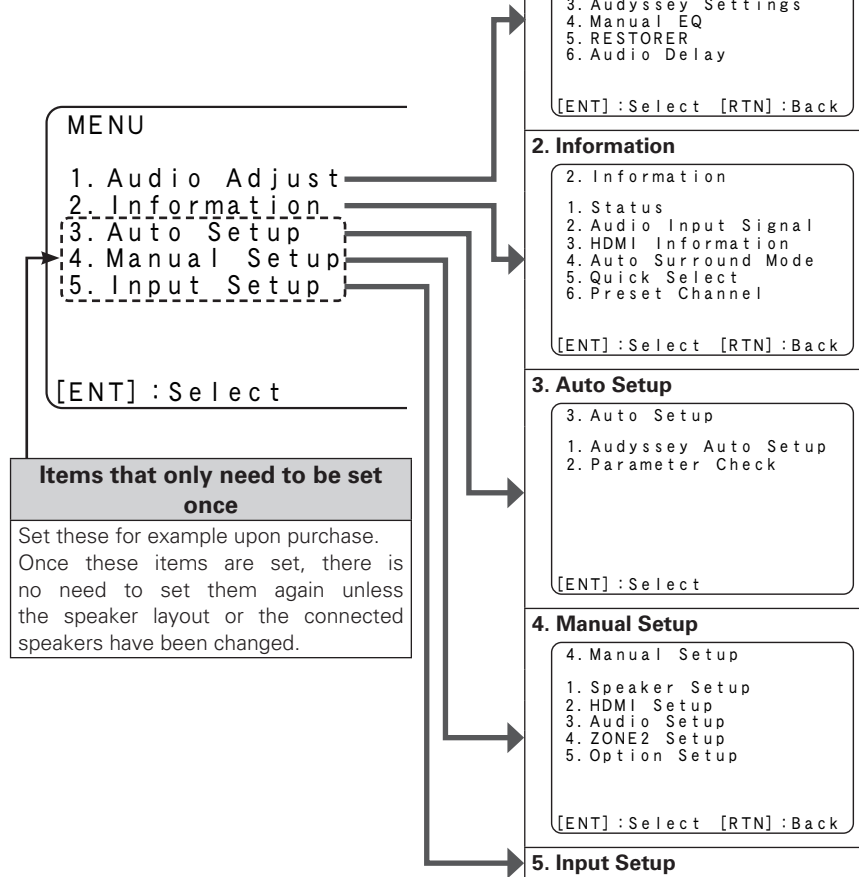

Setting items	Number	Detailed items	Description	Page
<b>1. Audio Adjust</b> 1. Audio Adjust 1. Surround Parameter 2. Tone 3. Audyssey Settings 4. Manual EQ 5. RESTORER 6. Audio Delay [ENT] : Select [RTN] : Back	1-1	<b>Surround Parameter</b>	Adjust surround sound parameters.	47
	1-2	<b>Tone</b>	Adjust the tonal quality of the sound.	49
	1-3	<b>Audyssey Settings</b>	Makes MultEQ®, Dynamic EQ® and Dynamic Volume™ settings.	49
	1-4	<b>Manual EQ</b>	Use the graphic equalizer to adjust the tone of each speaker.	51
	1-5	<b>RESTORER</b>	Uncompress compressed sources and apply bass boost for richer sound.	51
	1-6	<b>Audio Delay</b>	Compensate for incorrect timing between video and audio.	51
<b>2. Information</b> 2. Information 1. Status 2. Audio Input Signal 3. HDMI Information 4. Auto Surround Mode 5. Quick Select 6. Preset Channel [ENT] : Select [RTN] : Back	2-1	<b>Status</b>	Shows information about current settings.	59
	2-2	<b>Audio Input Signal</b>	Shows information about audio input signals.	59
	2-3	<b>HDMI Information</b>	Displays the HDMI input/output signals and HDMI monitor information.	59
	2-4	<b>Auto Surround Mode</b>	Displays the settings stored for the auto surround mode.	59
	2-5	<b>Quick Select</b>	Displays the settings stored for the Quick Select function.	59
	2-6	<b>Preset Channel</b>	Shows information about tuner preset channels.	59
<b>3. Auto Setup</b> 3. Auto Setup 1. Audyssey Auto Setup 2. Parameter Check [ENT] : Select	3-1	<b>Audyssey Auto Setup</b>	Makes the optimum settings for the speakers being used automatically.	6
	3-2	<b>Parameter Check</b>	Check Audyssey Auto Setup measurement results. This item is only displayed after Audyssey Auto Setup procedure has been performed.	10
<b>4. Manual Setup</b> 4. Manual Setup 1. Speaker Setup 2. HDMI Setup 3. Audio Setup 4. ZONE2 Setup 5. Option Setup [ENT] : Select [RTN] : Back	4-1	<b>Speaker Setup</b>	Sets the speaker size and distance, the channel level, etc.	52
	4-2	<b>HDMI Setup</b>	Make settings for HDMI video/audio output.	55
	4-3	<b>Audio Setup</b>	Make settings for audio playback.	55
	4-4	<b>ZONE2 Setup</b>	Make settings for audio playback in a ZONE2 system.	56
	4-5	<b>Option Setup</b>	Make various other settings.	57
<b>5. Input Setup</b>	-	<b>Auto Preset</b>	Use the auto preset function to program radio stations.	43
	-	<b>Preset Skip</b>	Set the preset memories that you do not want to display when tuning.	43
	-	<b>Preset Name</b>	Assign name to a preset memory.	44
	-	<b>Input Assign</b>	Change input connector assignment.	44
	-	<b>Video</b>	Makes the video settings.	45
	-	<b>Input Mode</b>	Sets the audio input mode and decode mode.	46
	-	<b>Rename</b>	Change the display name for this source.	46
	-	<b>Source Level</b>	Adjust the playback level of the audio input.	46
-	<b>Playback Mode</b>	Make settings for iPod or USB memory device playback.	46	



Displayed items of the "Input Setup" menu differs, depending on the selected input source.

## Examples of on-screen display and front display

Below we describe typical examples of displays on the TV screen and on the set's display window.

	On-screen Display	Front Display	Description
<b>Top menu display</b>			<ol style="list-style-type: none"> <li>1 The menu items are displayed here.</li> <li>2 The selected line is displayed here. The currently selected item is displayed on the display. Use <math>\Delta</math>/<math>\nabla</math> to move to the item you want to set.</li> <li>3 The number of the current selected setting menu is displayed.</li> </ol>
<b>Display when changing settings</b>	 	 	<ol style="list-style-type: none"> <li>1 The number of the current selected setting menu is displayed.</li> <li>2 Use <math>\Delta</math>/<math>\nabla</math>/<math>\triangleleft</math>/<math>\triangleright</math> to move to the item you want to set.</li> <li>3 Press <b>ENTER</b> to set to the mode in which the setting can be made.</li> <li>4 <math>\triangleleft</math>/<math>\triangleright</math> is displayed at the sides of items whose setting can be changed. Use <math>\triangleleft</math>/<math>\triangleright</math> to change to the desired setting.</li> </ol>
<b>Display when inputting characters</b>			<ol style="list-style-type: none"> <li>1 When <math>\triangleleft</math>/<math>\triangleright</math> is pressed, the cursor moves to the left or right.</li> <li>2 When <math>\Delta</math>/<math>\nabla</math> is pressed at the position at which you want to input the character, the character is input.</li> <li>3 The number of the current selected setting menu is displayed.</li> </ol> <p> For inputting characters on a keyboard screen or with the number buttons on the remote control unit, see page 41.</p>
<b>Display when resetting</b>		 	<ol style="list-style-type: none"> <li>1 Press <math>\nabla</math> to select "Default", then press <b>ENTER</b> to set.</li> <li>2 The number of the current selected setting menu is displayed.</li> </ol>

# Inputting characters

"PresetName" (page 44), "Rename" (page 46), "ZoneRename" (page 58) and "Quick Select Name" (page 57) can be changed as desired.

For inputting characters, there are three methods, as shown below.

## Method for inputting characters

Method	Operations
Using the number buttons (normal screen)	<ul style="list-style-type: none"> <li>Operating with the remote control unit.</li> <li>Multiple characters are assigned to a button, and each time the button is pressed, a character is switched.</li> </ul>
Using the cursor buttons (normal screen)	<ul style="list-style-type: none"> <li>Operating with the remote control unit or the main unit.</li> <li>Use <math>\Delta</math> <math>\nabla</math> <math>\triangleleft</math> <math>\triangleright</math> and <b>ENTER</b> to input characters.</li> </ul>
Using the keyboard screen	<ul style="list-style-type: none"> <li>Operating with the remote control unit.</li> <li>Select a character on the TV screen to input characters.</li> </ul>

## Normal screen

### Display of a normal input screen

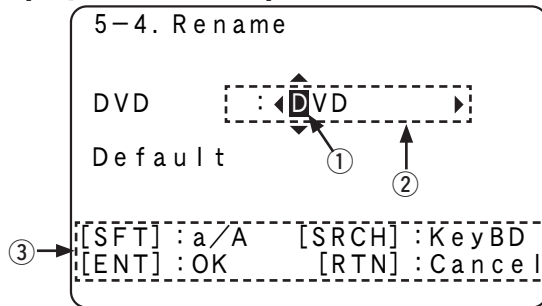

- ① Cursor
- ② Character input section
- ③ Guide for operation buttons
  - **[SFT] SHIFT** Switching upper- and lower-case characters
  - **[SRCH] SEARCH** Switching to the keyboard screen input method
  - **[ENT] ENTER** Registering an input character
  - **[RTN] RETURN** Canceling an input character

## Using the number buttons

- Display the screen for inputting characters. (page 39 "Menu map")
- Place the cursor at the character to be changed with  $\triangleleft$   $\triangleright$  and press the number button (0 - 9) until the desired character is displayed.
  - The types of characters that can be input are as shown below.
 

1 1 - . / :	6 M N O m n o 6
2 A B C a b c 2	7 P Q R S p q r s 7
3 D E F d e f 3	8 T U V t u v 8
4 G H I g h i 4	9 W X Y Z w x y z 9
5 J K L j k l 5	0 0 (Space) ' ( ) * + ; < = > ? [ ]
  - The input character type can be switched by pressing **SHIFT** while the display name is being changed.
  - For entering the characters assigned to one number button continuously, press  $\triangleright$  to move the cursor to the right after entering a character then enter the next character.
  - For entering characters assigned to separate buttons, press the number button continuously. The cursor automatically moves to the next position, and the input character is registered.
- Repeat step 2 to change the name then press **ENTER** to register it.

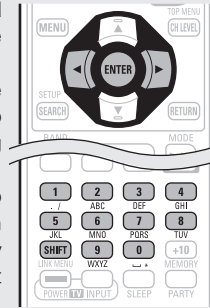

**Example:** For changing the input source from "DVD" to "DENON"

- Place the cursor at "V".
- Press **3** twice. "V" changes to "E".
- Press **6** twice. "E" is automatically registered, and "D" changes to "N".
- Press  $\triangleright$ . "N" is registered.
- Press **6** three times. Input "O".
- Press  $\triangleright$ . "O" is registered.
- Press **6** twice. Input "N".
- Press **ENTER** to register the input source name.

## Using the cursor buttons

- Display the screen for inputting characters. (page 39 "Menu map")
- Use  $\triangleleft$   $\triangleright$  to set the cursor to the character you want to change.
- Use  $\Delta$   $\nabla$  to change the character, then press **ENTER**.
  - The types of characters that can be input are as shown below.
 

<b>[Upper case characters]</b> ABCDEFGHIJKLMNOPQRSTUVWXYZ
<b>[Lower case characters]</b> abcdefghijklmnopqrstuvwxyz
<b>[Symbols]</b> ' ( ) * + - . / ; < = > ? [ ]
<b>[Numbers]</b> 0123456789 (Space)
  - The input character type can be switched by pressing **SHIFT** while the display name is being changed.
- Repeat steps 2 and 3 to rename then press **ENTER** to register it.



Inputting characters

Keyboard screen

Display of a keyboard input screen

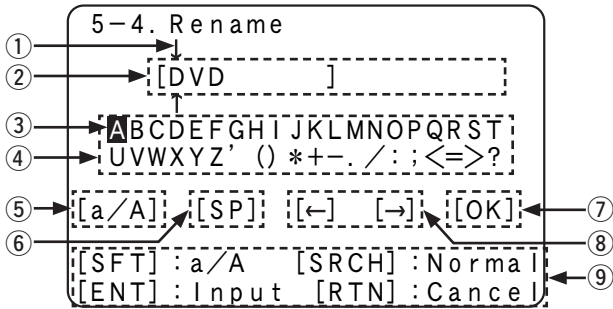

- ① Cursor
- ② Character input section
- ③ Cursor
- ④ Keyboard section
- ⑤ Upper (Symbols)- / lower (Numbers)-case character switching key
- ⑥ Space key
- ⑦ OK key
- ⑧ Cursor keys
- ⑨ Guide for operation buttons
  - [SFT] SHIFT Switching upper- and lower-case characters
  - [SRCH] SEARCH For switching to the normal screen input method
  - [ENT] ENTER For inputting a selected character
  - [RTN] RETURN Canceling an input character

- 1** Display the screen for inputting characters. (☞ page 39 “Menu map”)
- 2** Press **SEARCH** while a normal screen is displayed. A keyboard screen is displayed.
- 3** Select a character to be changed.
  - ① Press  $\Delta \nabla \triangleleft \triangleright$  to select “[←]” or “[→]”.
  - ② Press **ENTER** to place the cursor at the character to be changed. Each time **ENTER** is pressed, the cursor moves by one character.
- 4** Select a character to be input with  $\Delta \nabla \triangleleft \triangleright$  then press **ENTER**.
  - The types of characters that can be input are as shown below.

[Upper case characters/Symbols]  
 ABCDEFGHIJKLMNOPQRST  
 UVWXYZ ' ( ) \* + - . / : ; < = > ?

[Lower case characters/Numbers]  
 abcdefghijklmnopqrst  
 uvwxyz [ 0123456789
- 5** Repeat steps 3 and 4 to rename.
- 6** Use  $\Delta \nabla \triangleleft \triangleright$  to select “[OK]”, then press **ENTER**.



Input Setup

Perform settings related to input source playback.  
 • You do not have to change the settings to use the unit. Make settings when needed.

Menu operation

- 1** Press **ZONE SELECT** to switch the zone mode to “MAIN”. The “MAIN” indicator lights.
- 2** Press **AMP** to set the remote control unit to amplifier operation mode.
- 3** Press **MENU**. The menu is displayed on the TV screen.
- 4** Press  $\Delta \nabla$  to select the menu to be set or operated.
- 5** Press **ENTER** to enter the setting.
  - To return to the previous item, press **RETURN**.
  - Exiting the Menu, press **MENU** while the menu is displayed. The menu display disappears.

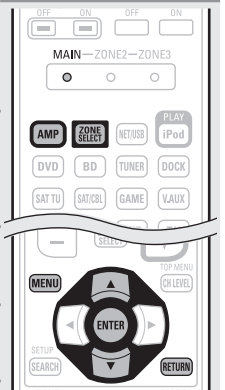

### Items that can be set with the Input Setup procedure

#### Auto Preset (☞ page 43)

```

5-1. Auto Preset
  Auto Tuning
  Preset Station Memory
  Storing Preset Memory
  Start
[ENT] : Start [RTN] : Back
    
```

#### Preset Skip (☞ page 43)

```

5-2. Preset Skip
  Block : A
  A Block Presets : ON
  A1 FM 87.50MHz : ON
  A2 FM 89.10MHz : ON
  A3 FM 98.10MHz : ON
  A4 FM107.90MHz : ON
  A5 FM 90.10MHz : ON
  A6 FM 90.10MHz : ON
  A7 FM 90.10MHz : ON
  A8 FM 90.10MHz : ON
[RTN] : Back
    
```

#### Preset Name (☞ page 44)

```

5-3. Preset Name
  Block : A
  A1FM 87.50MHz :
  A2FM 89.10MHz :
  A3FM 98.10MHz :
  A4FM107.90MHz :
  A5FM 90.10MHz :
  A6FM 90.10MHz :
  A7FM 90.10MHz :
  A8FM 90.10MHz :
[ENT] : Select [RTN] : Back
    
```

#### Input Assign (☞ page 44)

```

5-1. Input Assign
  Default HDMI Digi Comp
  BD 1
  DVD 2
  TV O1
  SAT/CBL 3 C1 1
  GAME 4
  V. AUX
[ENT] : Select [RTN] : Back
    
```

#### Video (☞ page 45)

```

5-2. Video
  Video Select : Source
  Video Mode : Auto
  i/p Scaler : Anlg/HDMI
  Resolution A : Auto
  Resolution H : Auto
  Progre. Mode : Auto
  Aspect : Full
[RTN] : Back
    
```

#### Input Mode (☞ page 46)

```

5-3. Input Mode
  Input Mode : Auto
  Decode Mode : Auto
[RTN] : Back
    
```

#### Rename (☞ page 46)

```

5-4. Rename
  BD : BD
  Default
[▲▼] : Up/Down [◀▶] : Rename
[RTN] : Back
    
```

#### Source Level (☞ page 46)

```

5-5. Source Level
  Source Level (A) : 0dB
  Source Level (D) : 0dB
[RTN] : Back
    
```

#### Playback Mode (☞ page 46)

```

5-4. Playback Mode
  Repeat Mode : OFF
  Shuffle Mode : OFF
[RTN] : Back
    
```

### Important information

#### About the display of input sources

In this section, the configurable input sources for each item are shown as follows.

BD DVD TV SAT/CBL GAME V.AUX DOCK USB/iPod TUNER CD

#### NOTE

Input sources that have been set to "Delete" at "Source Delete" (☞ page 57) cannot be selected.

### Auto Preset

Use the auto preset function to program radio stations.

Setting items	Setting details
<b>Start</b> Start the auto preset process. TUNER	If an FM station cannot be preset automatically, select the desired station by tuning it in manually, then preset it manually.

### Preset Skip

**Default settings are underlined.**

Set preset ch to be skipped when selecting.

Setting items	Setting details
<b>A - G</b> Set the preset channels you do not want to display. You can set by preset memory block (A to G) or by preset channel (1 to 8). TUNER	<b>1 - 8</b> : Set by individual preset channels in the currently selected preset memory block. • <u>ON</u> : Display the selected preset channel. • <u>Skip</u> : Do not display the selected preset channel. If you set "Block Presets" to "Skip", you can skip the preset memory blocks (A to G).



Input Setup

### Preset Name

Assign name to a preset memory.

Setting items	Setting details
<b>A1 – G8</b> Select the preset channel. <b>TUNER</b>	<ul style="list-style-type: none"> <li>Up to eight characters can be input.</li> <li>For character input, see page 41.</li> </ul>
<b>Default</b> The changed preset name is returned to the default setting.	<b>No</b> : Do not reset to the defaults. <b>Yes</b> : Reset to the defaults.

### Input Assign

#### Examples of input assign menu screen displays

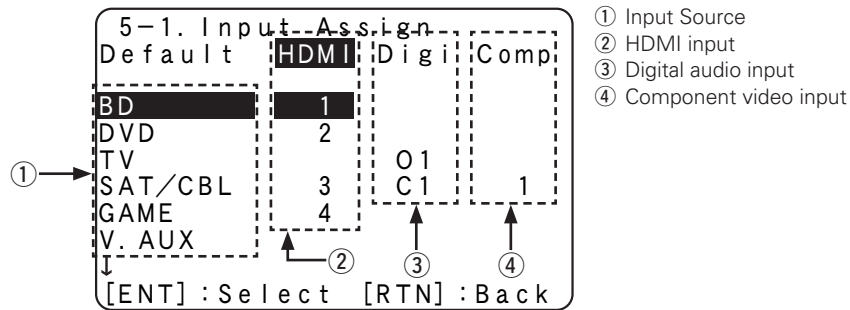

#### Input assignments menu operations

- Use  $\Delta \nabla \triangleleft \triangleright$  to move the highlight to the item you want to set.
- Press **ENTER**, then use  $\triangleleft \triangleright$  to select the input connector to be assigned.
- Press **ENTER** to enter the setting.



**NOTE**

If all "HDMI", "Digital" and "Component" assignment of the Game source are set to "None", Game source cannot be selected with the input source selection.

Setting items	Setting details																											
<b>HDMI</b> Set this to change the HDMI input connectors assigned to the input sources. <div style="display: flex; flex-wrap: wrap; gap: 5px;"> <span>BD</span> <span>DVD</span> <span>TV</span> </div> <div style="display: flex; flex-wrap: wrap; gap: 5px;"> <span>SAT/CBL</span> <span>GAME</span> </div> <div style="display: flex; flex-wrap: wrap; gap: 5px;"> <span>V.AUX</span> <span>DOCK</span> </div>	<b>HDMI 1 / HDMI 2 / HDMI 3 / HDMI 4</b> <b>None</b> : Do not assign an HDMI input connector to the selected input source. <ul style="list-style-type: none"> <li>At time of purchase, the settings of the different input sources are as shown below.</li> </ul> <table border="1" style="width: 100%; text-align: center;"> <thead> <tr> <th>Input source</th> <th>BD</th> <th>DVD</th> <th>TV</th> <th>SAT/CBL</th> <th>GAME</th> <th>V.AUX</th> <th>DOCK</th> </tr> </thead> <tbody> <tr> <td><b>Default setting</b></td> <td>HDMI 1</td> <td>HDMI 2</td> <td>None</td> <td>HDMI 3</td> <td>HDMI 4</td> <td>None</td> <td>None</td> </tr> </tbody> </table> <ul style="list-style-type: none"> <li>An input source to which an HDMI input connector cannot be assigned is displayed as "–".</li> <li>To play the video signal assigned at "HDMI" combined with the audio signal assigned at "Input Assign" – "Digital", select "Digital" at "Input Mode" (page 46).</li> <li>The audio signals input from the analog and digital connectors are not output to the monitor.</li> <li>Even if HDMI input connector is assigned to the input source "DOCK", "DOCK" is effective when a control dock for iPod is connected.</li> <li>When "HDMI Control" (page 55) is set to "ON", HDMI input connector cannot be assigned to "TV".</li> </ul>								Input source	BD	DVD	TV	SAT/CBL	GAME	V.AUX	DOCK	<b>Default setting</b>	HDMI 1	HDMI 2	None	HDMI 3	HDMI 4	None	None				
Input source	BD	DVD	TV	SAT/CBL	GAME	V.AUX	DOCK																					
<b>Default setting</b>	HDMI 1	HDMI 2	None	HDMI 3	HDMI 4	None	None																					
<b>Digital</b> Set this to change the digital input connectors assigned to the input sources. <div style="display: flex; flex-wrap: wrap; gap: 5px;"> <span>BD</span> <span>DVD</span> <span>TV</span> </div> <div style="display: flex; flex-wrap: wrap; gap: 5px;"> <span>SAT/CBL</span> <span>GAME</span> </div> <div style="display: flex; flex-wrap: wrap; gap: 5px;"> <span>V.AUX</span> <span>DOCK</span> <span>CD</span> </div>	<b>C1 (COAXIAL) / O1 (OPTICAL)</b> <b>None</b> : Do not assign a digital input connector to the selected input source. <ul style="list-style-type: none"> <li>At time of purchase, the settings of the different input sources are as shown below.</li> </ul> <table border="1" style="width: 100%; text-align: center;"> <thead> <tr> <th>Input source</th> <th>BD</th> <th>DVD</th> <th>TV</th> <th>SAT/CBL</th> <th>GAME</th> </tr> </thead> <tbody> <tr> <td><b>Default setting</b></td> <td>None</td> <td>None</td> <td>OPTICAL 1</td> <td>COAXIAL 1</td> <td>None</td> </tr> </tbody> </table> <table border="1" style="width: 100%; text-align: center;"> <thead> <tr> <th>Input source</th> <th>V.AUX</th> <th>DOCK</th> <th>CD</th> </tr> </thead> <tbody> <tr> <td><b>Default setting</b></td> <td>None</td> <td>None</td> <td>None</td> </tr> </tbody> </table>								Input source	BD	DVD	TV	SAT/CBL	GAME	<b>Default setting</b>	None	None	OPTICAL 1	COAXIAL 1	None	Input source	V.AUX	DOCK	CD	<b>Default setting</b>	None	None	None
Input source	BD	DVD	TV	SAT/CBL	GAME																							
<b>Default setting</b>	None	None	OPTICAL 1	COAXIAL 1	None																							
Input source	V.AUX	DOCK	CD																									
<b>Default setting</b>	None	None	None																									



Setting items	Setting details																									
<p><b>Component</b> Set this to change the component video input connectors assigned to the input sources.</p> <table border="1"> <tr> <td>BD</td> <td>DVD</td> <td>TV</td> </tr> <tr> <td>SAT/CBL</td> <td>GAME</td> <td></td> </tr> <tr> <td>V.AUX</td> <td>DOCK</td> <td></td> </tr> </table>	BD	DVD	TV	SAT/CBL	GAME		V.AUX	DOCK		<p><b>Comp1</b> (Component video) <b>None</b> : Do not assign a component video input connector to the selected input source.</p> <ul style="list-style-type: none"> <li>At time of purchase, the settings of the different input sources are as shown below.</li> </ul> <table border="1"> <tr> <th>Input source</th> <th>BD</th> <th>DVD</th> <th>TV</th> <th>SAT/CBL</th> <th>GAME</th> <th>V.AUX</th> <th>DOCK</th> </tr> <tr> <td><b>Default setting</b></td> <td>None</td> <td>None</td> <td>None</td> <td><u>Component 1</u></td> <td>None</td> <td>None</td> <td>None</td> </tr> </table> <ul style="list-style-type: none"> <li>An input source to which a component video input connector cannot be assigned is displayed as “-”.</li> <li>Even if a component input connector is assigned to the input source “DOCK”, “DOCK” is effective when a control dock for iPod is connected.</li> </ul>	Input source	BD	DVD	TV	SAT/CBL	GAME	V.AUX	DOCK	<b>Default setting</b>	None	None	None	<u>Component 1</u>	None	None	None
BD	DVD	TV																								
SAT/CBL	GAME																									
V.AUX	DOCK																									
Input source	BD	DVD	TV	SAT/CBL	GAME	V.AUX	DOCK																			
<b>Default setting</b>	None	None	None	<u>Component 1</u>	None	None	None																			
<p><b>Default</b> The “Input Assign” settings are returned to the default settings.</p>	<p><b>Yes</b> : Reset to the defaults. <b>No</b> : Do not reset to the defaults.</p> <ul style="list-style-type: none"> <li>If you select “Default” and press <b>ENTER</b>, the message “Default Setting?” is displayed. Select “Yes” or “No”, and then press <b>ENTER</b>.</li> </ul>																									

**Video**

Default settings are underlined.

Set the source video.

\* “BD”, “TV” or “GAME” can be set when “HDMI” (page 44) or “Component” (page 45) has been assigned.

Setting items	Setting details									
<p><b>Video Select</b> Video of another input source is played back combined with the playing audio.</p>	<p><b>Source</b> : Play the picture and sound of the input source. <b>BD / DVD / TV / SAT/CBL / GAME / V.AUX / DOCK</b> : Select video input source to view. This can be set for individual input sources.</p> <ul style="list-style-type: none"> <li>“BD”, “TV” and “GAME” can be selected only when a component video connector is assigned as an input source.</li> </ul> <p><b>NOTE</b></p> <ul style="list-style-type: none"> <li>It is not possible to select HDMI input signals.</li> <li>Input sources for which “Delete” is selected at “Source Delete” (page 57) cannot be selected.</li> </ul>									
<p><b>Video Mode</b> Make settings for video processing.</p> <table border="1"> <tr> <td>BD *</td> <td>DVD</td> <td>TV *</td> </tr> <tr> <td>SAT/CBL</td> <td>GAME *</td> <td></td> </tr> <tr> <td>V.AUX</td> <td>DOCK</td> <td></td> </tr> </table>	BD *	DVD	TV *	SAT/CBL	GAME *		V.AUX	DOCK		<p><b>Auto</b> : Process video automatically based on the HDMI content information. <b>Movie</b> : Process video normally. <b>Game</b> : Always process video appropriate for game content.</p>
BD *	DVD	TV *								
SAT/CBL	GAME *									
V.AUX	DOCK									

Setting items	Setting details									
<p><b>Video Mode</b> (Continued)</p>	<ul style="list-style-type: none"> <li>If “Video Mode” is set to “Auto”, the mode is switched according to the input contents.</li> <li>If a source is played in both MAIN ZONE (audio and video) and ZONE2 (audio only) modes in the same room, audio in MAIN ZONE and ZONE2 modes may sound out of synchronization, but this is not malfunction. In this case, setting to “Game” mode may improve audio synchronization.</li> </ul>									
<p><b>i/p Scaler</b> Convert the input source’s resolution to the resolution set at “Resolution”.</p> <table border="1"> <tr> <td>BD *</td> <td>DVD</td> <td>TV *</td> </tr> <tr> <td>SAT/CBL</td> <td>GAME *</td> <td></td> </tr> <tr> <td>V.AUX</td> <td>DOCK</td> <td></td> </tr> </table>	BD *	DVD	TV *	SAT/CBL	GAME *		V.AUX	DOCK		<p><b>Analog</b> : Use i/p scaler function for analog video signal. <b>Analog &amp; HDMI</b> : Use i/p scaler function for analog and HDMI video signal. <b>HDMI</b> : Use i/p scaler function for HDMI video signal. <b>OFF</b> : Do not use i/p scaler function.</p> <ul style="list-style-type: none"> <li>“Analog &amp; HDMI” and “HDMI” can be set for input sources for which an HDMI input connector is assigned.</li> <li>Which items can be set depend on the input source assigned to each input connector.</li> <li>This function is not effective when the input signal is x.v.Color, 3D, sYCC601 color, Adobe RGB color, Adobe YCC601 color or computer resolution.</li> </ul>
BD *	DVD	TV *								
SAT/CBL	GAME *									
V.AUX	DOCK									
<p><b>Resolution</b> Set the output resolution. Resolution A : Analog Video Resolution H : HDMI</p> <table border="1"> <tr> <td>BD *</td> <td>DVD</td> <td>TV *</td> </tr> <tr> <td>SAT/CBL</td> <td>GAME *</td> <td></td> </tr> <tr> <td>V.AUX</td> <td>DOCK</td> <td></td> </tr> </table>	BD *	DVD	TV *	SAT/CBL	GAME *		V.AUX	DOCK		<p><b>Auto</b> : The number of pixels the TV connected to the HDMI output connector supports is detected automatically and the appropriate output resolution is set. <b>480p / 576p / 1080i / 720p / 1080p</b> : Set the output resolution.</p> <ul style="list-style-type: none"> <li>This item can be set when “i/p Scaler” is set to anything other than “OFF”.</li> <li>When “i/p Scaler” is set to “Analog &amp; HDMI”, the resolution of both the analog video input signal and HDMI input signal can be set.</li> </ul>
BD *	DVD	TV *								
SAT/CBL	GAME *									
V.AUX	DOCK									
<p><b>Progressive Mode</b> Set an appropriate progressive conversion mode for the source video signal.</p> <table border="1"> <tr> <td>BD *</td> <td>DVD</td> <td>TV *</td> </tr> <tr> <td>SAT/CBL</td> <td>GAME *</td> <td></td> </tr> <tr> <td>V.AUX</td> <td>DOCK</td> <td></td> </tr> </table>	BD *	DVD	TV *	SAT/CBL	GAME *		V.AUX	DOCK		<p><b>Auto</b> : The video signal is automatically detected and the appropriate mode is set. <b>Video1</b> : Select mode suitable for video playback <b>Video2</b> : Select mode suitable for video and 30-frame film material playback.</p> <ul style="list-style-type: none"> <li>This item can be set when “i/p Scaler” is set to anything other than “OFF”.</li> </ul>
BD *	DVD	TV *								
SAT/CBL	GAME *									
V.AUX	DOCK									
<p><b>Aspect</b> Set the aspect ratio for the video signals output to the HDMI.</p> <table border="1"> <tr> <td>BD *</td> <td>DVD</td> <td>TV *</td> </tr> <tr> <td>SAT/CBL</td> <td>GAME *</td> <td></td> </tr> <tr> <td>V.AUX</td> <td>DOCK</td> <td></td> </tr> </table>	BD *	DVD	TV *	SAT/CBL	GAME *		V.AUX	DOCK		<p><b>Full</b> : Output at 16:9 aspect ratio. <b>Normal</b> : Output at 4:3 aspect ratio.</p> <ul style="list-style-type: none"> <li>“Aspect” can be set when “i/p Scaler” is set to anything other than “OFF”.</li> </ul>
BD *	DVD	TV *								
SAT/CBL	GAME *									
V.AUX	DOCK									







Input Setup

### Input Mode

Default settings are underlined.

The input modes available for selection may vary depending on the input source.

Setting items	Setting details
<b>Input Mode</b> Set the audio input modes for the different input sources.	<p><b>Auto</b> : Automatically detect input signal and perform playback.  <b>HDMI</b> : Play only signals from HDMI input.  <b>Digital</b> : Play only signals from digital input.  <b>Analog</b> : Play only signals from analog input.</p> <p></p> <ul style="list-style-type: none"> <li>• “HDMI” can be set for input sources for which “HDMI” is assigned at “Input Assign” (page 44).</li> <li>• “Digital” can be set for input sources for which “Digital” is assigned at “Input Assign” (page 44).</li> <li>• If the input source is set to “TV” or “Game”, it cannot be set to “Analog”.</li> <li>• When digital signals are properly input, the <b>DIG.</b> indicator lights on the display. If the <b>DIG.</b> indicator does not light, check the digital input connector assignment and the connections.</li> <li>• If “HDMI Control” is set to “ON” and a TV compatible with the ARC is connected via the HDMI MONITOR connectors, the input mode whose input source is “TV” is fixed to ARC.</li> </ul>
<b>Decode Mode</b> Set the decode mode for input source.	<p><b>Auto</b> : Detect type of digital input signal and decode and play automatically.  <b>PCM</b> : Decode and play only PCM input signals.  <b>DTS</b> : Decode and play only DTS input signals.</p> <p></p> <ul style="list-style-type: none"> <li>• This item can be set for input sources for which “HDMI” or “Digital” is assigned at “Input Assign” (page 44).</li> <li>• Normally set this mode to “Auto”. Set “PCM” and “DTS” when inputting the corresponding input signal.</li> </ul>

BD	DVD	TV
SAT/CBL	DOCK	
GAME	V.AUX	CD

### Rename

Change the display name of the selected input source.

Setting items	Setting details
<b>Rename</b> Change the display name of the selected input source.	<ul style="list-style-type: none"> <li>• Up to eight characters can be input.</li> <li>• For character input, see page 41.</li> </ul>
<b>Default</b> The input source name is returned to the default setting.	<p><b>Yes</b> : Reset to the defaults.  <b>No</b> : Do not reset to the defaults.</p>

### Source Level

Default settings are underlined.

- This function corrects the playback level of the selected input source’s audio input.
- Make this setting if there are differences in the input volume levels between the different sources.

**Setting details**

**-12dB – +12dB (0dB)**

-  The analog input level and digital input level can be adjusted independently for input sources for which “HDMI” or “Digital” is assigned at “Input Assign” (page 44).

### Playback Mode

This item can be set when the input source is “DOCK” or “USB/iPod”.

Setting items	Setting details
<b>Repeat</b> Make settings for repeat mode.	<p><input type="checkbox"/> <b>For iPod playback</b>  <b>All</b> : All files are played repeatedly.  <b>One</b> : A file being played is played repeatedly.  <b>OFF</b> : Repeat playback mode is canceled.</p> <p><input type="checkbox"/> <b>For USB memory device playback</b>  <b>All</b> : All files are played repeatedly.  <b>One</b> : A file being played is played repeatedly.  <b>Folder</b> : A file in the folder being played is played repeatedly.</p>
<b>Shuffle</b> Make settings for shuffle mode.	<p><input type="checkbox"/> <b>For iPod playback</b> (When iPod (USB/iPod), DENON control dock for iPod ASD-1R or ASD-11R is connected)  <b>Songs</b> : All files are played in shuffle playback mode.  <b>Albums</b> : Files in the album are played in shuffle playback mode.  <b>OFF</b> : Shuffle playback mode is canceled.</p> <p><input type="checkbox"/> <b>For iPod playback</b> (When DENON control dock for iPod ASD-3N, ASD-3W, ASD-51N or ASD-51W is connected)  <b>ON</b> : Shuffle playback mode is enabled.  <b>OFF</b> : Shuffle playback mode is canceled.</p> <p><input type="checkbox"/> <b>For USB memory device playback</b>  <b>ON</b> : Shuffle playback mode is enabled.  <b>OFF</b> : Shuffle playback mode is canceled.</p>



## Audio Adjust

The sound being played in the surround mode can be adjusted to your liking. The items (parameters) that can be adjusted depend on the signal being input and the currently set surround mode. For details on the adjustable parameters, see "Surround modes and surround parameters" (🔍 page 70).

### Menu operation

- 1** Press **ZONE SELECT** to switch the zone mode to "MAIN".  
The "MAIN" indicator lights.
- 2** Press **AMP** to set the remote control unit to amplifier operation mode.
- 3** Press **MENU**.  
The menu is displayed on the TV screen.
- 4** Press  $\Delta$ / $\nabla$  to select the menu to be set or operated.
- 5** Press **ENTER** to enter the setting.
  - To return to the previous item, press **RETURN**.
  - Exiting the Menu, press **MENU** while the menu is displayed.  
The menu display disappears.

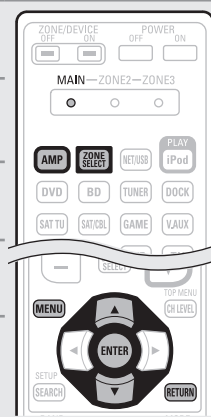

### Items that can be set with the Audio Adjust procedure

Surround Parameter (🔍 page 47)

Tone (🔍 page 49)

Audyssey Settings (🔍 page 49)

Manual EQ (🔍 page 51)



RESTORER (🔍 page 51)

Audio Delay (🔍 page 51)

## Surround Parameter



Default settings are underlined.





Adjust surround sound parameters. It may not be possible to set this item depending on the input signal.

Setting items	Setting details
<b>Mode</b> Set the play modes for the different surround modes.	<input type="checkbox"/> <b>In the PLIIx or PLII mode</b> <b>Cinema</b> : Surround sound mode optimized for movie sources. <b>Music</b> : Surround sound mode optimized for music sources. <b>Game</b> : Surround sound mode optimized for games. <b>Pro Logic</b> : Dolby Pro Logic playback mode (PLII mode only).
	<input type="checkbox"/> <b>In the PLIIz mode</b> <b>Height</b> : Dolby PLIIz Height playback mode.
	<input type="checkbox"/> <b>In the DTS NEO:6 mode</b> <b>Cinema</b> : Surround sound mode optimized for movie sources. <b>Music</b> : Surround sound mode optimized for music sources.
	 <ul style="list-style-type: none"> <li>• When "Surround Parameter" – "Front Height" (🔍 page 48) is set to "ON", the "Height" mode is set automatically.</li> <li>• The "Music" mode is also effective for movie sources including a lot of stereo music.</li> </ul>
<b>Cinema EQ</b> Soften the treble range of movie soundtracks for better understanding.	<b>OFF</b> : "Cinema EQ" is not used. <b>ON</b> : "Cinema EQ" is used.
<b>DRC</b> Compress dynamic range (difference between loud and soft sounds).	<b>Auto</b> : Automatic dynamic range compression on/off control according to source. This can be set in the Dolby TrueHD mode. <b>Low / Mid / High</b> : These set the compression level. <b>OFF</b> : Dynamic range compression always off.
<b>D.Comp</b> Compress dynamic range (difference between loud and soft sounds).	<b>Low / Mid / High</b> : These set the compression level. <b>OFF</b> : Turn dynamic range compression off.
<b>LFE</b> Adjust the low-frequency effects level (LFE).	<b>-10dB – 0dB</b>  For proper playback of the different sources, we recommend setting to the values below. <ul style="list-style-type: none"> <li>• Dolby Digital sources : "0dB"</li> <li>• DTS movie sources : "0dB"</li> <li>• DTS music sources : "-10dB"</li> </ul>
<b>Center Image</b> Assign center channel signal to front left and right channels for wider sound.	<b>0.0 – 1.0 (0.3)</b>



Audio Adjust

Setting items	Setting details
<b>Panorama</b> Assign front L/R signal also to surround channels for wider sound.	<b>ON</b> : Set. <b>OFF</b> : Do not set.
<b>Dimension</b> Shift sound image center to front or rear to adjust playback balance.	<b>0 – 6 (3)</b>
<b>Center Width</b> Assign center channel signal to front left and right channels for wider sound.	<b>0 – 7 (3)</b>
<b>Delay Time</b> Adjust delay time to control sound stage size.	<b>0ms – 300ms (30ms)</b>
<b>Effect Lev.</b> Adjust effect signal level.	<b>1 – 15 (10)</b>  Set to a lower level if the positioning and sense of phase of the surround signals seems unnatural.
<b>Room Size</b> Determine size of acoustic environment.	<b>Small</b> : Simulate acoustics of a small room. <b>Medium-S</b> : Simulate acoustics of a medium-small room. <b>Medium</b> : Simulate acoustics of a medium room. <b>Medium-L</b> : Simulate acoustics of a medium-large room. <b>Large</b> : Simulate acoustics of a large room. <div style="border: 1px solid black; border-radius: 10px; padding: 2px; display: inline-block; margin-top: 5px;"><b>NOTE</b></div> "Room Size" does not indicate the size of the room in which sources are played.
<b>AFDM (Auto flag detect mode)</b> Detect the source's surround back channel signal and set the optimum surround mode automatically.	<b>ON</b> : Set. <b>OFF</b> : Do not set. <b>[Example] Playing Dolby Digital software (with EX flag)</b> <ul style="list-style-type: none"> <li>• When "AFDM" is set to "ON", the surround mode is automatically set to the DOLBY D + PLIIx C mode.</li> <li>• To play in the DOLBY DIGITAL EX mode, set "AFDM" to "OFF" and "Surround Parameter" – "S.Back" to "MTRX ON".</li> </ul>  Some Dolby Digital EX sources do not include EX flags. If the playback mode does not switch automatically even when "AFDM" is set to "ON", set "Surround Parameter" – "S.Back" to "MTRX ON" or "PLIIx CINEMA".

Setting items	Setting details
<b>S.Back</b> Sets the method of generating of the surround back channel.	<input type="checkbox"/> <b>For 2-channel sources</b> <b>ON</b> : The surround back channel is used. <b>OFF</b> : No signal is played from the surround back channels. <input type="checkbox"/> <b>For Multi-channel sources</b> Set the decoding method for the surround back channel. <b>DSCRT ON</b> : Play the surround back signals included in the 7.1-channel source. <b>MTRX ON</b> : Generate and play the surround back signals from the surround channel signals. <b>ES MTRX*1</b> : Generate and play the surround back signals from the surround channel signals of the DTS source. <b>ES DSCRT*2</b> : Play the surround back signals included in the 6.1-channel DTS source. <b>PLIIx CINEMA*3</b> : Generate and play the surround back signals by decoding the signals in the Dolby Pro Logic IIx Cinema mode. <b>PLIIx MUSIC</b> : Generate and play the surround back signals by decoding the signals in the Dolby Pro Logic IIx Music mode. <b>OFF</b> : Do not play the surround back channel.  *1 This can be selected when playing DTS sources. *2 This can be selected when playing DTS sources including a signal to identify discrete 6.1-channel signals. *3 This can be selected when "Speaker Config." – "S.Back" (  page 53) is set to "2sp".   This can also be set by pressing <b>STANDARD</b> . • If the source being played contains a surround back signal, the decoder type is automatically selected by the AFDM function. Set "AFDM" to "OFF" to switch to your preferred decoder.  <div style="border: 1px solid black; border-radius: 10px; padding: 2px; display: inline-block; margin-top: 5px;"><b>NOTE</b></div> If the setting in "Speaker Config." – "S.Back" (  page 53) is "None", "S.Back" is not displayed.
<b>Front Height</b> Determine whether to use front height channel.	<b>ON</b> : Audio is output from the front height speaker. <b>OFF</b> : Audio is not output from the front height speaker.  <div style="border: 1px solid black; border-radius: 10px; padding: 2px; display: inline-block; margin-top: 5px;"><b>NOTE</b></div> • "Front Height" is displayed with the settings listed below. • When "Amp Assign" (  page 52) is set to "Front Height". • When the "Speaker Config." – "Front Height" setting (  page 53) is set to other than "None". • "Front Height" cannot be set if the HD Audio source being played includes a front height channel. In this case, the Front height channel is played back without decoding in PLIIz mode, using the input signal.

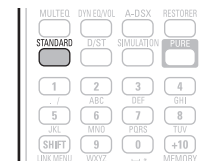



Setting items	Setting details
<b>Height Gain</b> Control the front height channel volume.	<b>Low</b> : Reduce the front height channel volume. <b>Mid</b> : Front height channel sound is output with standard sound volume. <b>High</b> : Increase the front height channel volume. <b>NOTE</b> "Height Gain" is displayed for the following settings. <ul style="list-style-type: none"> <li>• When "Amp Assign" (🔧 page 52) is set to "Front Height".</li> <li>• When the "Speaker Config." – "Front Height" setting (🔧 page 53) is set to other than "None".</li> <li>• When surround mode is "PLIIz" or the PLIIz decoder is used.</li> </ul>
<b>Subwoofer</b> Turn subwoofer output on and off.	<b>ON</b> : The subwoofer is used. <b>OFF</b> : The subwoofer is not used.
<b>Default</b> The "Surround Parameter" settings are returned to the default settings.	<b>No</b> : Do not reset to the defaults. <b>Yes</b> : Reset to the defaults.

## Tone

**Default settings are underlined.**

Adjust the tonal quality of the sound.

Setting items	Setting details
<b>Tone Control</b> Set the tone control function to ON and OFF.	<b>ON</b> : Allow tone adjustment (bass, treble). <b>OFF</b> : Playback without tone adjustment.  "Tone Control" can be set when "Dynamic EQ" (🔧 page 50) is set to "OFF". <b>NOTE</b> <ul style="list-style-type: none"> <li>• "Tone Control" settings are not reflected to ZONE2.</li> <li>• The tone cannot be adjusted in the direct mode.</li> </ul>
<b>Bass</b> Adjust low frequency range (bass).	<b>-6dB – +6dB (0dB)</b>  "Bass" can be set when "Tone Control" is set to "ON".
<b>Treble</b> Adjust high frequency range (treble).	<b>-6dB – +6dB (0dB)</b>  "Treble" can be set when "Tone Control" is set to "ON".



## Audyssey Settings

**Default settings are underlined.**

Set MultEQ®, Dynamic EQ® and Dynamic Volume™. These can be selected after Audyssey® Auto Setup has been performed. For additional information on Audyssey technology, please see page 74.





### NOTE

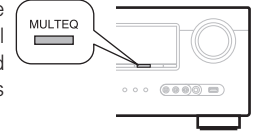

If you have not performed Auto Setup, or if you change the speaker settings after performing Auto Setup, you may not be able to select Dynamic EQ/Dynamic Volume, and "Run Audyssey" may be displayed. In this case, either perform Audyssey Auto Setup over again or perform "Restore" (🔧 page 10) to return to the settings after Audyssey Auto Setup was run.

Setting items	Setting details
<b>MultEQ</b> Select one equalizer from three modes. MultEQ corrects both time and frequency response problems in the listening area based on Audyssey Auto Setup calibration. We recommend "Audyssey". MultEQ is the prerequisite function for Dynamic EQ and Dynamic Volume.	<b>Audyssey</b> : Optimize the frequency response of all speakers. <b>Audyssey Byp.L/R</b> : Optimize frequency response of speakers except front L and R speakers. <b>Audyssey Flat</b> : Optimize frequency response of all speakers to flat response. <b>Manual</b> : Apply frequency response set with "Manual EQ" (🔧 page 51). <b>OFF</b> : Turn "MultEQ" equalizer off.  <ul style="list-style-type: none"> <li>• "Audyssey", "Audyssey Byp. L/R" and "Audyssey Flat" can be selected after Audyssey Auto Setup has been performed. "Audyssey" is automatically selected after performing Audyssey Auto Setup. When "Audyssey", "Audyssey Byp. L/R" or "Audyssey Flat" is selected,  illuminates.</li> <li>• After running Audyssey Auto Setup, if the Speaker Configuration, Distance, Channel Level, and Crossover Frequency have changed without increasing the number of speakers measured, only  illuminates.</li> <li>• Pressing <b>MULTEQ</b> on the remote control unit or the main unit makes this setting.</li> </ul> <b>NOTE</b> <ul style="list-style-type: none"> <li>• "MultEQ" and "Manual" cannot be selected when "EQ Customize" is set to "Not Used" (🔧 page 56).</li> <li>• When using headphones, "MultEQ" is automatically set to "OFF".</li> </ul>

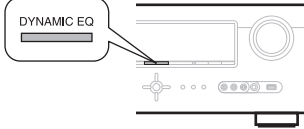

Audio Adjust

Setting items	Setting details
<p><b>Dynamic EQ®</b> Solve the problem of deteriorating sound quality as volume is decreased by taking into account human perception and room acoustics.</p>	<p><b>ON</b> : Use Dynamic EQ. <b>OFF</b> : Do not use Dynamic EQ.</p> <p> is displayed when set to "ON".</p> <ul style="list-style-type: none"> <li>Buttons on the remote control unit or main unit can be used for operations.</li> </ul> <p><b>[Operations with the remote control unit]</b> Press <b>DYN EQ/VOL</b>. Each time <b>DYN EQ/VOL</b> is pressed, the setting is changed as shown below.</p>  <p><b>[Operations with the main unit]</b> Press <b>DYNAMIC EQ</b>. Each time <b>DYNAMIC EQ</b> is pressed, the setting is changed as shown below.</p>  <p>Dynamic EQ : ON ↔ Dynamic EQ : OFF</p>
<p><b>Reference Level Offset</b> Audyssey Dynamic EQ is referenced to the standard film mix level. It makes adjustments to maintain the reference response and surround envelopment when the volume is turned down from 0 dB. However, film reference level is not always used in music or other non-film content. Dynamic EQ Reference Level Offset provides three offsets from the film level reference (5 dB, 10 dB, and 15 dB) that can be selected when the mix level of the content is not within the standard.</p>	<p><b>0dB</b> (Film Ref) : This is the default setting and should be used when listening to movies. <b>5dB</b> : Select this setting for content that has a very wide dynamic range, such as classical music. <b>10dB</b> : Select this setting for jazz or other music that has a wider dynamic range. This setting should also be selected for TV content as that is usually mixed at 10 dB below film reference. <b>15dB</b> : Select this setting for pop/rock music or other program material that is mixed at very high listening levels and has a compressed dynamic range.</p> <p> Setting is enabled when "Dynamic EQ" is "ON" (page 50).</p>

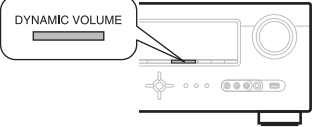
Setting items	Setting details
<p><b>Dynamic Volume™</b> Solve the problem of large variations in volume level between TV, movies and other content (between quiet passages and loud passages, etc.) by automatically adjusting to the user's preferred volume setting.</p>	<p><b>Midnight</b> : Most adjustment to softest and loudest sounds. <b>Evening</b> : Medium adjustment to loudest and softest sound. <b>Day</b> : Least adjustment to loudest and softest sounds. <b>OFF</b> : Do not use the "Dynamic Volume".</p> <p> is displayed when set to "ON".</p> <ul style="list-style-type: none"> <li>If "Dynamic Volume" is set to "Yes" in Auto Setup (page 9), the setting is automatically changed to "Evening".</li> <li>Buttons on the remote control unit or main unit can be used for operations.</li> </ul> <p><b>[Operations with the remote control unit]</b> Press <b>DYN EQ/VOL</b>. Each time <b>DYN EQ/VOL</b> is pressed, the setting is changed as shown below.</p>  <p><b>[Operations with the main unit]</b> Press <b>DYNAMIC VOLUME</b>. Each time <b>DYNAMIC VOLUME</b> is pressed, the setting is changed as shown below.</p> 



## Manual EQ

Use the graphic equalizer to adjust the tone of each speaker.  
 "Manual EQ" can be set when "MultEQ®" setting (page 49) is "Manual".

Setting items	Setting details
<b>Adjust CH</b> Correct the tone of each speaker.	<ol style="list-style-type: none"> <li>Select the speaker tone adjustment method.  <b>All CH</b> : Adjust the tone of all speakers together.  <b>L/R CH</b> : Adjust the tone of left and right speakers together.  <b>Each CH</b> : Adjust the tone of each speaker.</li> <li>Select the speaker.</li> <li>Select the adjustment frequency band.  <b>63Hz / 125Hz / 250Hz / 500Hz / 1kHz / 2kHz / 4kHz / 8kHz / 16kHz</b>            • Select the speakers you want to adjust when "L/R" or "Each" is selected.</li> <li>Adjust the level.  <b>-20.0dB – +6.0dB (0.0dB)</b></li> </ol>
<b>Base Curve Copy</b> Copy "Audyssey Flat" curve from MultEQ.	<b>Yes</b> : Copy. <b>No</b> : Do not copy.  "Base Curve Copy" is displayed after Audyssey Auto Setup has been performed.
<b>Default</b> The "Manual EQ" settings are returned to the default settings.	<b>No</b> : Do not reset to the defaults. <b>Yes</b> : Reset to the defaults.

## RESTORER

Compressed audio formats such as MP3, WMA (Windows Media Audio) and MPEG-4 AAC reduce the amount of data by eliminating signal components that are hard for the human ear to hear. The RESTORER function generates the signals eliminated upon compression, restoring the sound to conditions near those of the original sound before compression. It also corrects the sense of volume of the bass to obtain richer sound with compressed audio signals.

### Setting details

**OFF** : Do not use RESTORER.

**Mode 1** (RESTORER 64) : Optimized mode for compressed sources with very weak highs.

**Mode 2** (RESTORER 96) : Apply suitable bass and treble boost for all compressed sources.

**Mode 3** (RESTORER HQ) : Optimized mode for compressed sources with normal highs.



- This item can be set with analog signals or when a PCM signal (fs = 44.1/48 kHz) is input.
- This cannot be set when the surround mode is set to "DIRECT" or "PURE DIRECT".
- This item default setting for "iPod" and "USB/iPod" is "Mode 3". All others are set to "OFF".
- When set to something other than "OFF", **RSTR** is displayed.
- Pressing **RESTORER** on the remote control unit or the main unit makes this setting.

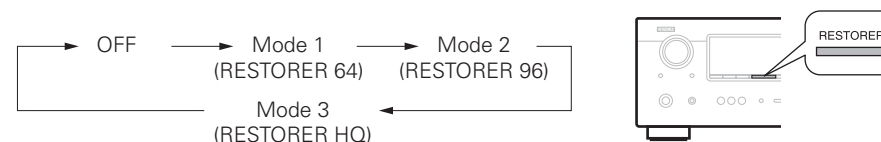

## Audio Delay

Default settings are underlined.

While viewing video, manually adjust the time to delay audio output.

### Setting details

0ms – 200ms



- This item can be set within the range of 0 to 100 ms when "Auto Lip Sync" is set to "ON" and when a TV compatible with Auto Lip Sync is connected.
- Store "Audio Delay" for each input source.
- Audio Delay for game mode can be set when "Video Mode" (page 45) is set to "Game".



# Manual Setup

Set when changing Audyssey® Auto Setup settings, or when changing the audio, video, display or other settings.

- If you change the speaker settings after performing Audyssey Auto Setup, it will not be possible to set MultEQ®, Dynamic EQ® and Dynamic Volume™ (page 49, 50).
- Can be used without changing the settings. Please set if necessary.

## Menu operation

- 1 Press **ZONE SELECT** to switch the zone mode to “MAIN”.  
The “MAIN” indicator lights.
- 2 Press **AMP** to set the remote control unit to amplifier operation mode.
- 3 Press **MENU**.  
The menu is displayed on the TV screen.
- 4 Press **△▽** to select the menu to be set or operated.
- 5 Press **ENTER** to enter the setting.

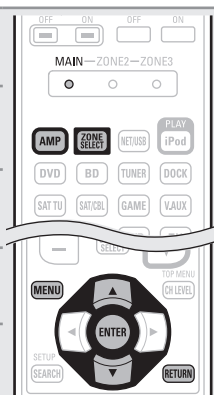

- To return to the previous item, press **RETURN**.
- Exiting the Menu, press **MENU** while the menu is displayed.  
The menu display disappears.

## Items that can be set with the Manual Setup procedure

### Speaker Setup (page 52)

#### 4-1. Speaker Setup

1. Amp Assign
2. Speaker Config.
3. Bass Setting
4. Distance
5. Channel Level
6. Crossover Freq.

[ENT] : Select [RTN] : Back

### HDMI Setup (page 55)

#### 4-2. HDMI Setup

- Auto Lipsync : ON
- HDMI Audio Out : Amp
- HDMI Control : OFF

[RTN] : Back

### Audio Setup (page 55)

#### 4-3. Audio Setup

1. 2ch Direct/Stereo
2. Auto Surround Mode
3. EQ Customize

[ENT] : Select [RTN] : Back

### ZONE2 Setup (page 56)

#### 4-4. ZONE2 Setup

- Level Lch : 0dB
- Level Rch : 0dB
- Vol. limit : OFF
- Power On Lev : Last
- Mute Lev. : Full

[RTN] : Back

### Option Setup (page 57)

#### 4-5. Option Setup

1. Volume Control
2. Source Delete
3. On-Screen Display
4. Remote Preset Codes
5. Quick Select Name
6. ZONE Rename
7. Display

[ENT] : Select [RTN] : Back

# Speaker Setup





Default settings are underlined.









Perform when setting the speakers manually or when changing settings made in Audyssey Auto Setup.

- If you change the speaker settings after performing Audyssey Auto Setup, it will not be possible to select MultEQ, Dynamic EQ and Dynamic Volume (page 49, 50).
- Manual Setup can be used without changing the settings. Please set if necessary.

Setting items	Setting details
<b>Amp Assign</b> Set the speakers connected to this unit.	<p><b>Normal</b> : Set when using 7.1-channel (Front/Center/Surround/Surround Back/Subwoofer) speakers.</p> <p><b>ZONE2</b> : Set for connecting the speakers for ZONE2 to the SURR. BACK/AMP ASSIGN terminals.</p> <p><b>Front Height</b> : Set for connecting the front height speakers to the SURR. BACK/AMP ASSIGN terminals.</p> <p><b>Front Bi-Amp</b> : Set for connecting a tweeter of a front speaker to the SURR. BACK/AMP ASSIGN terminals and a woofer of the front speaker to the FRONT terminals.</p> <p><b>Front B</b> : Set for connecting the second front speakers to the SURR. BACK/AMP ASSIGN terminals. In this case, make settings for “Front Speaker Setup” (page 54).</p>
<b>Speaker Config.</b> Select speaker configuration and size (bass reproduction capability).	<p><b>Front</b> : Set the front speaker size.</p> <ul style="list-style-type: none"> <li>• <b>Large</b> : Use a large speaker that can adequately play back low frequencies.</li> <li>• <b>Small</b> : Use a small speaker that has inadequate playback capacity for low frequencies.</li> </ul> <p><b>NOTE</b></p> <p>Do not use the outward shape of the speaker to determine selection of a “Large” or “Small” speaker. Instead, use the frequencies set in “Crossover Frequency” (page 54) as the standard for determining bass reproduction capability.</p> <p><b>NOTE</b></p> <ul style="list-style-type: none"> <li>• When “Subwoofer” is set to “No”, “Front” is automatically set to “Large”.</li> <li>• When “Front” is set to “Small”, “Center”, “Surround”, “Surround Back” and “Front Height” can not be set to “Large”.</li> </ul> <p><b>Center</b> : Set the presence and size of the center speaker.</p> <ul style="list-style-type: none"> <li>• <b>Large</b> : Use a large speaker that can adequately play back low frequencies.</li> <li>• <b>Small</b> : Use a small speaker that has inadequate playback capacity for low frequencies.</li> <li>• <b>None</b> : Select when a center speaker is not connected.</li> </ul> <p>“Large” is not displayed when “Front” is set to “Small”.</p> <p><b>Subwoofer</b> : Set the presence of a subwoofer.</p> <ul style="list-style-type: none"> <li>• <b>Yes</b> : Use a subwoofer.</li> <li>• <b>No</b> : Select when a subwoofer is not connected.</li> </ul> <p>When “Front” is set to “Small”, “Subwoofer” is automatically set to “Yes”.</p>





Setting items	Setting details
<b>Speaker Config.</b> (Continued)	<p><b>Surround</b> : Set the presence and size of the surround speakers.</p> <ul style="list-style-type: none"> <li>• <b>Large</b> : Use a large speaker that can adequately play back low frequencies.</li> <li>• <b>Small</b> : Use a small speaker that has inadequate playback capacity for low frequencies.</li> <li>• <b>None</b> : Select when the surround speakers are not connected.</li> </ul> <p> When "Surround" is set to "Large", "Surround Back" and "Front Height" can be set to "Large".</p> <p>When "Surround" is set to "None", "Surround Back" and "Front Height" can automatically set to "None".</p> <hr/> <p><b>S.Back</b> : Set the presence, size and number of surround back speakers.</p> <ul style="list-style-type: none"> <li>• <b>Large</b> : Use a large speaker that can adequately play back low frequencies.</li> <li>• <b>Small</b> : Use a small speaker that has inadequate playback capacity for low frequencies.</li> <li>• <b>None</b> : Select when the surround back speakers are not connected.</li> <li>• <b>2sp</b> : Use two surround back speakers.</li> <li>• <b>1sp</b> : Use only one surround back speaker. When you select this setting, connect the surround back speaker to the left (L) channel.</li> </ul> <p> Even when the "S.Back" setting is other than "None", sound may not be emitted from the surround back speaker, depending on the playback source. In this case, make "Surround Parameter" – "S.Back" setting other than "OFF" ( page 48).</p> <p><b>NOTE</b></p> <p>When the "Amp Assign" setting ( page 52) is other than "Normal", you cannot make the "S.Back" setting.</p> <hr/> <p><b>Front Height</b> : Set the presence and size of the front height speakers.</p> <ul style="list-style-type: none"> <li>• <b>Large</b> : Use a large speaker that can adequately play back low frequencies.</li> <li>• <b>Small</b> : Use a small speaker that has inadequate playback capacity for low frequencies.</li> <li>• <b>None</b> : Select when the front height speakers are not connected.</li> </ul> <p><b>NOTE</b></p> <p>When the "Amp Assign" setting ( page 52) is other than "Front Height", you cannot make the "Front Height" setting.</p>

Setting items	Setting details
<b>Bass Setting</b> Set subwoofer and LFE signal range playback.	<p><b>Subwoofer Mode</b> : Select low range signals to be reproduced by subwoofer.</p> <ul style="list-style-type: none"> <li>• <b>LFE</b> : The low range signal of the channel set to "Small" speaker size is added to the LFE signal output from the subwoofer.</li> <li>• <b>LFE+Main</b> : The low range signal of all channels is added to the LFE signal output from the subwoofer.</li> </ul> <p> "Subwoofer Mode" can be set when "Speaker Config." – "Subwoofer" ( page 52) is set to "Yes".</p> <ul style="list-style-type: none"> <li>• Play music or a movie source and select the mode offering the strongest bass.</li> <li>• Select "LFE+Main" if you want the bass signals to always be produced from the subwoofer.</li> </ul> <p><b>NOTE</b></p> <p>If "Front" and "Center" for "Speaker Config." are set to "Large", and "Subwoofer Mode" is set to "LFE", no sound may be output from the subwoofers, depending on the input signal or selected surround mode.</p> <hr/> <p><b>LPF for LFE</b> : Set LFE signal playback range.</p> <p>• <b>80Hz / 90Hz / 100Hz / 110Hz / 120Hz / 150Hz / 200Hz / 250Hz</b></p> <hr/> <p><b>Distance</b>                      Set distance from listening position to speakers. Measure beforehand the distance from the listening position to each speaker.</p> <p><b>Unit</b> : Set the unit of distance.</p> <ul style="list-style-type: none"> <li>• <b>Feet / Meters</b></li> </ul> <p><b>Step</b> : Set the minimum variable width of the distance.</p> <ul style="list-style-type: none"> <li>• <b>1ft / 0.1ft</b></li> <li>• <b>0.1m / 0.01m</b></li> </ul> <p><b>FL / FR / C / SW / SL / SR / SBL* / SBR* / FHL / FHR</b> : Select the speaker.</p> <p>* When the "Speaker Config." – "S.Back" setting ( page 53) is set to "1sp", "S.Back" is displayed.</p> <ul style="list-style-type: none"> <li>• <b>0.0ft – 60.0ft / 0.00m – 18.00m</b> : Set the distance.</li> </ul> <p> The speakers that can be selected differ depending on the "Amp Assign" ( page 52) and "Speaker Config." ( page 52) settings.</p> <ul style="list-style-type: none"> <li>• Default settings :                      FL / FR / C / SW / FHL / FHR : 12.0 ft (3.6 m)                      SL / SR / SBL / SBR : 10.0 ft (3.0 m)</li> <li>• Set the difference in the distance between the speakers to less than 20 ft (6.0 m).</li> </ul> <p><b>NOTE</b></p> <p>Speakers set to "None" in "Speaker Config." ( page 52) are not displayed.</p> <p><b>Default</b> : The "Distance" settings are returned to the default settings.</p> <ul style="list-style-type: none"> <li>• <b>Yes</b> : Reset to the defaults.</li> <li>• <b>No</b> : Do not reset to the defaults.</li> </ul> <p> When you select "Default" and press <b>ENTER</b>, the "Default Setting?" prompt is displayed. Select either "Yes" or "No", and press <b>ENTER</b>.</p>





Manual Setup

Setting items	Setting details
<p><b>Channel Level</b> Set the volume of the test tone to be the same when it is output from each speaker.</p>	<p><b>Test Tone Start</b> : Output test tone.</p> <ul style="list-style-type: none"> <li>• <b>FL / C / FR / SR / SBR* / SBL* / SL / FHL / FHR / SW</b> : Select the speaker.</li> <li>* When the "Speaker Config." – "S.Back" setting (🔍 page 53) is set to "1sp", "S.Back" is displayed.</li> <li>• <b>-12.0dB – +12.0dB (0.0dB)</b> : Adjust the volume.</li> </ul> <p></p> <ul style="list-style-type: none"> <li>• When ◀ is pressed while the subwoofer volume is set to "-12 dB", the "Subwoofer" setting switches to "OFF".</li> <li>• When "Channel Level" is adjusted, the adjusted values are set for all the surround modes. To adjust the channel level separately for the different surround modes, use the operation see page 35.</li> </ul> <p><b>NOTE</b></p> <ul style="list-style-type: none"> <li>• Speakers set to "None" in the "Speaker Config." (🔍 page 52) settings are not displayed.</li> <li>• When a headphones jack is inserted in the PHONES jack of this unit, the "Channel Level" is not displayed.</li> </ul> <p><b>Default</b> : The "Channel Level" settings are returned to the default settings.</p> <ul style="list-style-type: none"> <li>• <b>No</b> : Do not reset to the defaults.</li> <li>• <b>Yes</b> : Reset to the defaults.</li> </ul>
<p><b>Crossover Frequency</b> Set the maximum frequency of the bass signal output from each channel to the subwoofer. Set the Crossover Frequency to suit the bass reproduction capability of the speaker being used.</p>	<p><b>Crossover</b> : Set the crossover frequency.</p> <ul style="list-style-type: none"> <li>• <b>40Hz / 60Hz / 80Hz / 90Hz / 100Hz / 110Hz / 120Hz / 150Hz / 200Hz / 250Hz</b></li> </ul> <p><b>Advanced</b> : Specify crossover frequency for each speaker.</p> <ul style="list-style-type: none"> <li>• <b>Front / Center / Surround / S.Back / Front Height</b> : Select the speaker.</li> <li>• <b>40Hz / 60Hz / 80Hz / 90Hz / 100Hz / 110Hz / 120Hz / 150Hz / 200Hz / 250Hz</b> : Set the crossover frequency.</li> </ul> <p></p> <ul style="list-style-type: none"> <li>• "Crossover Frequency" can be set when the "Bass Setting" – "Subwoofer Mode" (🔍 page 53) setting is "LFE+Main", or when you have a speaker that is set to "Small".</li> <li>• Always set the crossover frequency to "80Hz". When using small speakers, however, we recommend setting the crossover frequency to a higher frequency.</li> <li>• For speakers set to "Small", sound below the crossover frequency is cut from the sound output. The cut bass sound is output from the subwoofer or front speakers.</li> <li>• The speakers that can be set when "Advanced" is selected differ according to the "Subwoofer Mode" setting (🔍 page 53).             <ul style="list-style-type: none"> <li>• When "LFE" is selected, speakers set to "Small" at "Speaker Config." can be set. If the speakers are set to "Large", "Full Band" is displayed and the setting cannot be made.</li> <li>• If set to "LFE+Main", this setting can be made regardless of the speaker size.</li> </ul> </li> </ul>





Setting items	Setting details
<p><b>Front Speaker Setup</b> Set the front speakers to use for every surround mode.</p> <p><b>NOTE</b> This can be set when "Amp Assign" is set to "Front B" (🔍 page 52).</p>	<p><b>DIRECT/STEREO</b> : The front speakers used in the direct, stereo and pure direct play modes (2 channel) are set in advance.</p> <ul style="list-style-type: none"> <li>• <b>A</b> : Front speaker A is used.</li> <li>• <b>B</b> : Front speaker B is used.</li> <li>• <b>A+B</b> : Both front speakers A and B are used.</li> </ul> <p><b>MULTI CH</b> : The front speakers used in modes other than the direct, stereo and pure direct play modes (2 channel) are set in advance.</p> <ul style="list-style-type: none"> <li>• <b>A</b> : Front speaker A is used.</li> <li>• <b>B</b> : Front speaker B is used.</li> <li>• <b>A+B</b> : Both front speakers A and B are used.</li> </ul>



## HDMI Setup

Default settings are underlined.





Make settings for HDMI video/audio output.

Setting items	Setting details
<b>Auto Lip Sync</b> Make automatic compensation for timing shift in audio and video output.	<b>ON</b> : Compensated. <b>OFF</b> : Not compensated.
<b>HDMI Audio Out</b> Select HDMI audio output device.	<b>Amp</b> : Play back through speakers connected to the receiver. <b>TV</b> : Play back through TV connected to the receiver.  When the HDMI control function is activated, priority is given to the TV audio setting (page 34 "HDMI control function").
<b>HDMI Control</b> You can link operations with devices connected to HDMI and compatible with HDMI Control.	<b>ON</b> : Use HDMI control function. <b>OFF</b> : Do not use HDMI control function.  <ul style="list-style-type: none"> <li>When a device that is not compatible with the HDMI control function is connected, set "HDMI Control" to "OFF".</li> <li>Please consult the operating instructions for each connected component to check the settings.</li> <li>Refer to "HDMI control function" (page 34) for more information about the HDMI control function.</li> </ul> <p><b>NOTE</b></p> <ul style="list-style-type: none"> <li>When "HDMI Control" is set to "ON", it consumes more standby power. If you are not using this unit for an extended period, it is recommended that you unplug the power cord from the power outlet.</li> <li>"HDMI Control" does not work when the power to the equipment is off. Either turn power on or set to standby.</li> <li>The HDMI control function controls operations of a TV that is compatible with the HDMI control function. Make sure that the TV and HDMI are connected when you perform HDMI control.</li> <li>If the "HDMI Control" settings have been changed, always reset the power to connected devices after the change.</li> </ul>
<b>Standby Source</b> Sets the HDMI input source to put into standby when the power is on.	<b>Last</b> : This item is set at the last-used input source. <b>HDMI1 / HDMI2 / HDMI3 / HDMI4</b> : Put the respective input source into standby.  "Standby Source" can be set when "HDMI Control" is set to "ON".
<b>Power Off Control</b> Links the power standby of this unit to external equipment.	<b>All</b> : If power to a connected TV is turned off independently of the input source, power to this unit is automatically set to standby. <b>Video</b> : If power to a connected TV is turned off when the input source is BD / DVD / TV / SAT/CBL / GAME / V.AUX / DOCK, power to this unit is automatically set to standby. <b>OFF</b> : This unit does not link with power to a TV.  "Power Off Control" can be set when "HDMI Control" is set to "ON".

## Audio Setup





Default settings are underlined.

Make settings for audio playback.

Setting items	Setting details
<b>2ch DIRECT/STEREO</b> Select the method for setting the speakers used in the 2-channel direct and stereo playback modes.	<b>Setting</b> : Select the method for setting the speakers used in the 2-channel direct and stereo playback modes. <ul style="list-style-type: none"> <li><b>Basic</b> : The settings at "Speaker Setup" (page 52) are applied.</li> <li><b>Custom</b> : Make separate settings for 2-channel. Make the following settings:</li> </ul>
	<b>Front</b> : Set the front speaker size. <ul style="list-style-type: none"> <li><b>Large</b> : Use a large speaker that can adequately play back low frequencies.</li> <li><b>Small</b> : Use a small speaker that has inadequate playback capacity for low frequencies.</li> </ul>  If "Speaker Config." – "Subwoofer" (page 52) is set to "No", the setting is automatically set to "Large".
	<b>Subwoofer</b> : Set the presence of a subwoofer. <ul style="list-style-type: none"> <li><b>Yes</b> : Use a subwoofer.</li> <li><b>No</b> : Select when a subwoofer is not connected.</li> </ul>  If "Speaker Config." – "Subwoofer" (page 52) is set to "No", the setting is automatically set to "No". If the "Front" setting is "Small", the setting is automatically "Yes".
	<b>Subwoofer Mode</b> : Select low range signals to be reproduced by subwoofer. <ul style="list-style-type: none"> <li><b>LFE</b> : When the "2ch DIRECT/STEREO" – "Front" setting is set to "Large", the LFE signal alone is output from the subwoofer. Also, when the "2ch DIRECT/STEREO" – "Front" setting is set to "Small", the front channel low range signal is added to the LFE signal output from the subwoofer.</li> <li><b>LFE+Main</b> : The front channel low range signal is added to the LFE signal output from the subwoofer.</li> </ul>  This setting can be set made "2ch DIRECT/STEREO" – "Subwoofer" is set to "Yes".
	<b>Crossover</b> : Set the maximum frequency of the bass signal output from each channel to the subwoofer. <ul style="list-style-type: none"> <li><b>40Hz / 60Hz / 80Hz / 90Hz / 100Hz / 110Hz / 120Hz / 150Hz / 200Hz / 250Hz</b></li> </ul>  <ul style="list-style-type: none"> <li>This setting can be set made "2ch DIRECT/STEREO" – "Subwoofer" is set to "Yes".</li> <li>If the "2ch DIRECT/STEREO" – "Front" setting is "Large" and the "Subwoofer Mode" setting is "LFE", "Full Band" is displayed and the setting cannot be made.</li> </ul>



Manual Setup

Setting items	Setting details
<b>2ch DIRECT/STEREO</b> (Continued)	<p><b>Distance FL / Distance FR</b> : Select the speaker.</p> <ul style="list-style-type: none"> <li>• <b>0.0ft – 60.0ft (12.0ft) / 0.00m – 18.00m (3.60m)</b> : Set the distance to the speaker.</li> </ul> <p> Set so that the difference between the front left speaker and front right speaker distances is 20.0 ft (6.0 m) or less.</p> <p><b>Level FL / Level FR</b> : Select the speaker.</p> <ul style="list-style-type: none"> <li>• <b>-12.0dB – +12.0dB (0.0dB)</b> : Adjust the level of each channel.</li> </ul>
<b>Auto Surround Mode</b> Make setting for memorizing surround mode setting for each input signal type.	<p><b>ON</b> : Memorize settings. Automatically play with the last used surround mode.</p> <p><b>OFF</b> : Do not memorize settings. Surround mode does not change according to input signal.</p> <p> The auto surround mode function lets you store in the memory the surround mode last used for playing the four types of input signals listed below.</p> <ol style="list-style-type: none"> <li>① Analog and PCM 2-channel signals</li> <li>② Dolby Digital and DTS 2-channel signals</li> <li>③ Dolby Digital and DTS multi-channel signals</li> <li>④ LPCM Multi-channel signals</li> </ol> <ul style="list-style-type: none"> <li>• When playing in PURE DIRECT, the surround mode does not change even if the input signal is changed.</li> </ul>
<b>EQ Customize</b> Set so that unused equalizer settings are not displayed when <b>MULTEQ</b> is pressed.	<p><b>Audyssey Byp. L/R</b> : Set when not using “Audyssey Byp. L/R” equalizer.</p> <ul style="list-style-type: none"> <li>• <b>Used</b> : Use.</li> <li>• <b>Not Used</b> : Do not use.</li> </ul> <p> Set so that “Audyssey Byp. L/R” settings can be made when Audyssey Auto Setup is performed.</p> <p><b>Audyssey Flat</b> : Set when not using “Audyssey Flat” equalizer.</p> <ul style="list-style-type: none"> <li>• <b>Used</b> : Use.</li> <li>• <b>Not Used</b> : Do not use.</li> </ul> <p> Set so that “Audyssey Flat” settings can be made when Audyssey Auto Setup is performed.</p> <p><b>Manual</b> : Set when not using the “Manual” equalizer.</p> <ul style="list-style-type: none"> <li>• <b>Used</b> : Use.</li> <li>• <b>Not Used</b> : Do not use.</li> </ul>

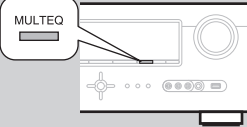



 The equalizer mode in which “Not Used” is selected cannot be stored and recalled in the Quick Select function.

**ZONE2 Setup**

Default settings are underlined.

Set the audio to play back with ZONE2.  
 “ZONE2 Setup” is displayed when “ZONE2” is selected with “Amp Assign”.

Setting items	Setting details
<b>Level Lch</b> Adjust the left channel output level.	<p><b>-12dB – +12dB (0dB)</b></p>
<b>Level Rch</b> Adjust the right channel output level.	<p><b>-12dB – +12dB (0dB)</b></p>
<b>Volume Limit</b> Make a setting for maximum volume.	<p><b>OFF</b> : Do not set a maximum volume.</p> <p><b>-20dB (61) / -10dB (71) / 0dB (81)</b></p> <p> This is displayed from 0 – 99 when “Volume Display” (page 57) is set to “Absolute”.</p>
<b>Power On Level</b> Define the volume setting that is active when the power is turned on.	<p><b>Last</b> : Use the memorized setting from the last session.</p> <p><b>---</b> (<b>0</b>) : Always mute when power is turned on.</p> <p><b>-80dB – 18dB (1 – 99)</b> : The volume is adjusted to the set level.</p> <p> This is displayed from 0 – 99 when “Volume Display” (page 57) is set to “Absolute”.</p>
<b>Mute Level</b> Set the amount of attenuation when muting is on.	<p><b>Full</b> : The sound is muted entirely.</p> <p><b>-40dB</b> : The sound is attenuated by 40 dB down.</p> <p><b>-20dB</b> : The sound is attenuated by 20 dB down.</p>



# Option Setup

Default settings are underlined.

Make various other settings.

Setting items	Setting details
<b>Volume Control</b> Set the MAIN ZONE (room where the unit is located) volume setting.	<b>Volume Display</b> : Set how volume is displayed. • <b>Relative</b> : Display -dB (Min), in the range -80.5 dB - 18 dB. • <b>Absolute</b> : Display in the range 0 (Min) - 99.  • The "Volume Display" setting is applied also to the "Volume Limit" and "Power On Level" display method. • The "Volume Display" setting applies to all zones. <b>Volume Limit</b> : Make a setting for maximum volume. • <b>OFF</b> : Do not set a maximum volume. • <b>-20dB (61) / -10dB (71) / 0dB (81)</b> <b>Power On Level</b> : Define the volume setting that is active when the power is turned on. • <b>Last</b> : Use the memorized setting from the last session. • <b>---</b> ( <b>0</b> ) : Always use the muting on condition when power is turned on. • <b>-80dB - 18dB (1 - 99)</b> : The volume is adjusted to the set level. <b>Mute Level</b> : Set the amount of attenuation when muting is on. • <b>Full</b> : The sound is muted entirely. • <b>-40dB</b> : The sound is attenuated by 40 dB down. • <b>-20dB</b> : The sound is attenuated by 20 dB down.
<b>Source Delete</b> Remove from the display input sources that are not used.	<b>BD / DVD / TV / SAT/CBL / V.AUX / GAME / DOCK / USB/iPod / TUNER / CD</b> : Select input source that is not used. • <b>ON</b> : Use this source. • <b>Delete</b> : Do not use this source. <div style="border: 1px solid black; border-radius: 10px; padding: 2px; display: inline-block; margin: 5px 0;"><b>NOTE</b></div> • Input sources being used in the various zones cannot be deleted. • Input sources set to "Delete" cannot be selected using <b>SOURCE SELECT</b> .
<b>On-Screen Display</b> Make the settings related to displays on the TV screen.	<b>Screensaver</b> : Make screensaver settings. • <b>ON</b> : The screen saver is activated during menu display, iPod, USB/iPod or TUNER screen display if no operation is performed for an approximately 3-minute continuous period. When you press $\Delta \nabla \triangleleft \triangleright$ , the screensaver is cancelled and the screen before that screen saver started is displayed. • <b>OFF</b> : Screensaver is not activated. <b>Text</b> : Display the details of operation when switching surround mode, input mode, etc. • <b>ON</b> : Turn display on. • <b>OFF</b> : Turn display off.

Setting items	Setting details
<b>On-Screen Display</b> (Continued)	<b>Master Volume</b> : Display the master volume during adjustment. • <b>Bottom</b> : Display at the bottom. • <b>Top</b> : Display at the top. • <b>OFF</b> : Turn display off.  When the master volume display is hard to see when superimposed on movie subtitles, set to "Top". <b>USB</b> : Set the USB screen display time when the input source is "USB/iPod". • <b>Always</b> : Show display continuously. • <b>30sec</b> : Show display for 30 seconds after operation. • <b>10sec</b> : Show display for 10 seconds after operation. • <b>OFF</b> : Turn display off. <b>iPod</b> : Set the iPod screen display time when the input source is "DOCK" or "USB/iPod". • <b>Always</b> : Show display continuously. • <b>30sec</b> : Show display for 30 seconds after operation. • <b>10sec</b> : Show display for 10 seconds after operation. • <b>OFF</b> : Turn display off. <b>TUNER</b> : Set the tuner screen display time when the input source is "TUNER". • <b>Always</b> : Show display continuously. • <b>30sec</b> : Show display for 30 seconds after operation. • <b>10sec</b> : Show display for 10 seconds after operation. • <b>OFF</b> : Turn display off.
<b>Remote Preset Codes</b> Search a preset code to register in the remote control unit.	See "Registering preset codes" (page 60).
<b>Quick Select Name</b> Change the "Quick Select" display title to one you prefer.	<b>Rename Label</b> : Select this to change the displayed name for "Quick Select" shown on the screen, as desired. • Up to 16 characters can be input. • For character input, see page 41.

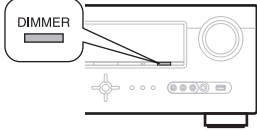

Manual Setup

Setting items	Setting details
<b>Quick Select Name</b> (Continued)	<p><b>Template</b> : The display name can be changed by selecting "Operation" and "Device Name" from the previously set templates.</p> <ol style="list-style-type: none"> <li>Use <math>\Delta \nabla</math> to select the name of the Quick Select setting you want to change, then press <b>ENTER</b>.</li> <li>Use <math>\Delta \nabla</math> to select "Template", then press <b>ENTER</b>.</li> <li>Use <math>\Delta \nabla</math> to select "Operation", then press <b>ENTER</b>.                             <ul style="list-style-type: none"> <li>• <b>Watch / Listen to / Play / For</b></li> </ul> </li> <li>Use <math>\Delta \nabla \triangleleft \triangleright</math> to select "Device Name", then press <b>ENTER</b>.                             <ul style="list-style-type: none"> <li>• <b>BD / DVD / TV / Cable TV / Satellite / DVR / VCR / iPod / V.AUX / LD / Movie (When "Operation" is selected to "Watch".)</b></li> <li>• <b>CD / TUNER / iPod / MD / Tape / Music (When "Operation" is selected to "Listen to".)</b></li> <li>• <b>PC / Game (When "Operation" is selected to "Play".)</b></li> <li>• <b>Father / Mother / Son / Daughter / Brother / Sister / Grandfather / Grandmother / Me (When "Operation" is selected to "For".)</b></li> </ul> </li> </ol> <p><b>Default</b> : The changed "Quick Select Name" is returned to the default setting.</p> <ul style="list-style-type: none"> <li>• <b>No</b> : Do not reset to the defaults.</li> <li>• <b>Yes</b> : Reset to the defaults.</li> </ul>
<b>Zone Rename</b> Change the display title of each zone to one you prefer.	<ul style="list-style-type: none"> <li>• Up to 10 characters can be input.</li> <li>• For character input, see page 41.</li> </ul> <p><b>Default</b> : The changed display names are reset to the defaults.</p> <ul style="list-style-type: none"> <li>• <b>No</b> : Do not reset to the defaults.</li> <li>• <b>Yes</b> : Reset to the defaults.</li> </ul>
<b>Display</b> Adjust the display brightness of this unit.	<p><b>Bright</b> : Normal display brightness.  <b>Dim</b> : Reduced display brightness.  <b>Dark</b> : Very low display brightness.  <b>OFF</b> : Turns the display off.</p> <p> Buttons on the main unit can be used for operations. Each time <b>DIMMER</b> is pressed, the setting is changed as shown below.</p> <div style="display: flex; align-items: center;"> <div style="margin-right: 20px;"> <p>Bright → Dim</p> <p>← Dark ← OFF</p> </div>  </div>

Setting items	Setting details
<b>Setup Lock</b> Protect settings from inadvertent change.	<p><b>ON</b> : Turn protection on.  <b>OFF</b> : Turn protection off.</p> <p> When canceling the setting, set "Setup Lock" to "OFF".</p> <p><b>NOTE</b></p> <p>When "Setup Lock" is set to "ON", the settings listed below can no longer be changed. Also, "SETUP LOCKED!" is displayed if you attempt to operate related settings.</p> <ul style="list-style-type: none"> <li>· Menu operations</li> <li>· RESTORER</li> <li>· MultEQ<sup>®</sup></li> <li>· Dynamic EQ<sup>®</sup></li> <li>· Dynamic Volume™</li> <li>· Channel Level</li> </ul>



# Information

Show information about receiver settings, input signals, etc.

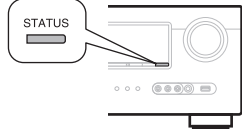
Items	Setting details
<p><b>Status</b> Show information about current settings.</p> <p><b>NOTE</b> The information displayed differs according to the input source.</p>	<p><input type="checkbox"/> <b>MAIN ZONE</b> This item shows information about settings for MAIN ZONE. <b>Select Source / Name / Surround Mode / Input Mode / Decode Mode / Video Select / Video Mode / Content Type / Video Convert / i/p Scaler / Resolution / Progressive Mode / Aspect</b> etc.</p> <p><input type="checkbox"/> <b>ZONE2</b> This item shows information about settings for ZONE2. <b>Power / Select Source / Volume Level</b></p> <p> "Status" for ZONE2 is displayed when "Amp Assign" is set to "ZONE2".</p>
<p><b>Audio Input Signal</b> Show information about audio input signals.</p>	<p><b>Surround Mode</b> : The currently set surround mode. <b>Signal</b> : The input signal type. <b>fs</b> : The input signal's sampling frequency. <b>Format</b> : The number of channels in the input signal (front, surround, LFE). <b>Offset</b> : The dialogue normalization correction value. <b>Flag</b> : This is displayed when inputting signals including a surround back channel. "MATRIX" is displayed with Dolby Digital EX and DTS-ES Matrix signals, "DISCRETE" with DTS-ES Discrete signals.</p> <div style="border: 1px solid black; padding: 5px;"> <p style="text-align: center;"><b>Dialogue normalization function</b></p> <p>This function is automatically activated when playing Dolby Digital sources. It automatically corrects the standard signal level for individual program sources. The correction value can be checked using <b>STATUS</b>.</p> <div style="display: flex; align-items: center;"> <div style="border: 1px solid black; padding: 5px; margin-right: 10px;">Offset - 4dB</div> <p>The figure is the corrected value. This cannot be changed.</p> </div>  </div>
<p><b>HDMI Information</b> Show information about HDMI input/output signals and monitor.</p>	<p><b>HDMI Signal Information</b> • <b>Resolution / Color Space / Pixel Depth</b></p> <p><b>HDMI Monitor Information</b> • <b>Interface / Support Resolution</b></p>
<p><b>Auto Surround Mode</b> Show information about auto surround mode settings.</p>	<p><b>Analog/PCM / Digital 2ch / Digital 5.1ch / Multi Ch</b></p>

Items	Setting details
<p><b>Quick Select</b> Show information about "Quick select function" (page 36) settings.</p>	<p><b>Quick Select 1 / Quick Select 2 / Quick Select 3 / ZONE2 Quick Select 1 / ZONE2 Quick Select 2 / ZONE2 Quick Select 3</b></p> <p>• <b>Name / Input Source / Video Select / Volume Level / MultEQ® / Dynamic EQ® / Dynamic Volume™ / Analog/PCM / Digital 2ch / Digital 5.1ch / Multi Ch</b></p> <p> "ZONE2 Quick Select" is displayed when "Amp Assign" is set to "ZONE2".</p>
<p><b>Preset Channel</b> Show information about preset channels.</p> <p><b>TUNER</b></p>	<p><b>A / B / C / D / E / F / G</b> <b>A1 - A8 / B1 - B8 / C1 - C8 / D1 - D8 / E1 - E8 / F1 - F8 / G1 - G8</b></p>

Simple version

Basic version

Advanced version

Information

Remote control operation buttons



Move the cursor (Up/Down/Left/Right)



Confirm the setting



Return to previous menu

# Operating the connected devices by remote control unit

Registering the supplied preset codes in the remote control unit enables you to operate devices made by other manufacturers.

## Operating AV equipment

### 1 Press ZONE SELECT to select a zone for operation.

The zone mode indicator corresponding to the operating zone lights.

- The mode switches each time **ZONE SELECT** is pressed.

**MAIN** Select for the operations in MAIN ZONE.

**ZONE2** Select for the operations in ZONE2.

**ZONE3** Not used.

- If setting of "Specifying the zone used with the remote control unit" (page 63) is "2", operations in MAIN ZONE and ZONE2 are enabled.



### 2 Press the input source select button (page 20).

- The input source for the zone selected in step 1 is switched.
- The operation mode of the remote control unit is switched as shown in the table.

Input source select buttons	Input source of this unit	Devices controllable with the remote control unit (Operation mode)
AMP	–	This unit (amplifier operation)
BD *	BD	Device registered on the <b>BD</b> button
DVD *	DVD	Device registered on the <b>DVD</b> button
TV *	TV	Device registered on the <b>TV</b> button
SAT/CBL *	SAT/CBL	Device registered on the <b>SAT/CBL</b> button
GAME *	GAME	Device registered on the <b>GAME</b> button
V.AUX *	V.AUX	Device registered on the <b>V.AUX</b> button
CD *	CD	Device registered on the <b>CD</b> button
TUNER	TUNER	Radio of this unit
NET/USB	USB/iPod	iPod or USB memory device connected to the USB port
iPod	USB/iPod or DOCK	iPod connected to the USB port or control dock for iPod.
DOCK	DOCK	Control dock for iPod

\* If a preset code is registered for this button, the remote control unit of this unit can control another devices.

#### NOTE

If the mode of the remote control unit is set to other than amp-operation mode, press **AMP** to switch the remote control unit to the amp-operation mode to perform the following operations:

- For menu operation by pressing **MENU**
- For setting the channel level of the unit by pressing **CH LEVEL**
- For turning power in each zone on or off by pressing **ZONE/DEVICE ON** or **ZONE/DEVICE OFF**.

### 3 Operate this unit or the device whose input source is switched.

- For details, refer to the operating instructions for each device. For operations of iPod, TUNER, and USB, see the following pages.
  - iPod (page 22, 23)
  - TUNER (page 24)
  - USB memory device (page 25)

## Registering preset codes

When preset codes are registered in the included remote control unit, it can then be used to operate any devices you have, such as DVD players or TVs made by different manufacturers.

In this menu, you can search and display the preset codes that can be preset in the included remote control unit.

### Buttons used for operating the devices

#### ① ZONE/DEVICE ON, ZONE/DEVICE OFF

For switching power of each device on or off.

#### ② $\Delta$ $\nabla$ $\triangleleft$ $\triangleright$ , ENTER, RETURN

For menu operation of each device.

#### ③ MENU, SETUP, TOP MENU

For displaying the menu of each device.

#### ④ $\blacktriangleright$ , $\blacksquare$ , $\mathbb{I}$ , $\blacktriangleleft$ , $\blacktriangleright$ , $\mathbb{I}$ , $\blacktriangleleft$ , $\blacktriangleright$

#### ⑤ Number button (0 – 9, +10)

#### ⑥ CH +, CH –

#### ⑦ TV POWER, TV INPUT

For operating a TV

This button is enabled in any mode.

For details on operation with the remote control unit, see pages 22 to 25, 62, and 63.

### Default settings for preset codes

The devices shown below are registered for each input source button as default. Settings can be changed according to the devices to be used.

Input source select buttons	Category	Brand	Preset code
BD	Blu-ray Disc player	DENON	32258
DVD	DVD player	DENON	32134
TV	Television	SONY	10810
SAT/CBL	Satellite set top box	DirecTV	01377
GAME	Cable set top box	Motorola	01376
V.AUX	DVD player	DENON	32134
CD	CD player	DENON	42867
DOCK *	Control dock for iPod	DENON	42517

\* If a control dock for iPod is not to be used, the preset code for another device can be set to **DOCK**.

#### NOTE

- The preset code cannot be registered to **TUNER** or **NET/USB**.
- Do not register the preset code to **iPod**. This button also functions as the Play button for an iPod.

**1** Press **ZONE SELECT** to switch the zone mode to “MAIN”.  
The “MAIN” indicator lights.

**2** Press **AMP** to set the remote control unit to amplifier operation mode.

**3** Press **MENU**.  
The menu is displayed on the TV screen.

**4** Use  $\Delta$ / $\nabla$  to select “Manual Setup” – “Option Setup” – “Remote Preset Codes” and then press **ENTER**.

```
4-5. Option Setup
1. Volume Control
2. Source Delete
3. On-Screen Display
4. Remote Preset Codes
5. Quick Select Name
6. Zone Rename
7. Display
↓
[ENT]:Select [RTN]:Back
```

**5** Pressing  $\Delta$ / $\nabla$ , select the category of device for preset registration. Then press **ENTER**.

```
4-5-4. RC Preset Codes
Category Search
Blu-ray
CD
CD Recorder
CABLE
CABLE/PVR
DVD
↓
[ENT]:Select [RTN]:Back
```

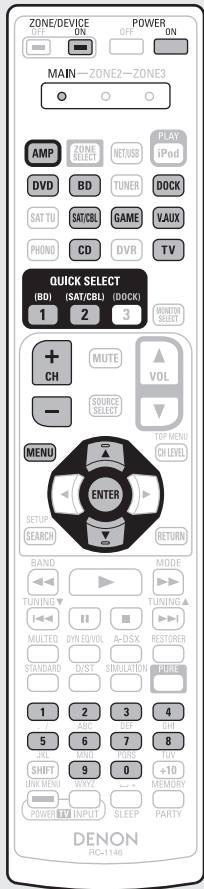

**6** Pressing  $\Delta$ / $\nabla$ , select the first character of the brand name. Then press **ENTER**.

```
Brand Search - DVD -
↑
1
A
B
C
D
E
↓
[ENT]:Select [RTN]:Back
```

- The first character is displayed as 1, A to Z. (Initials for the brand are displayed for each category.)  
For brand names that start with numbers, select “1”.

**7** Pressing  $\Delta$ / $\nabla$ , select the brand name. Then press **ENTER**.

```
Brand [1/1] - DVD -
↑
Daewoo
Dantax
Denon
Disney
DSE
Durabrand
↓
[ENT]:Select [RTN]:Back
```

- When there are several pages of brand names, the pages can be switched by pressing the remote control unit’s **CH +** or **CH -**.

**NOTE**

If the desired brand name is not listed, the supplied remote control unit cannot control the device. Use the remote control unit supplied with the device to be used.

**8** The procedures for registering remote control codes and remote control preset registration are displayed.

```
Category :DVD
Brand :DENON
Code [1/3] :30490
Setup Remote
1. Press [Source] button.
2. Press and Hold 3sec. both [PowerON] [DeviceON]
3. Input Code with [0-9]
4. Press any key to check device [e.g. DeviceON]
[QUICK1]:OK [QUICK2]:NG
```

**9** Press the input source button on which the preset code is to be registered (DVD, BD, SAT/CBL, DOCK, V.AUX, GAME, CD or TV).

- For **TV**, only the preset code for the categories “TV”, “TV/DVD”, or “TV/VCR” can be registered.
- For “TV”, “TV/DVD”, or “TV/VCR” categories, only the preset code for **TV** can be registered.

**10** Hold **POWER ON** and **ZONE/DEVICE ON** pressed simultaneously for more than 3 seconds.  
The zone mode indicator flashes twice.

**11** Enter a five-digit code using **0 - 9**.  
Press the buttons with an interval less than 10 seconds.

```
Category :DVD
Brand :DENON
Code [1/3] :30490
Setup Remote
1. Press [Source] button.
2. Press and Hold 3sec. both [PowerON] [DeviceON]
3. Input Code with [0-9]
4. Press any key to check device [e.g. DeviceON]
[QUICK1]:OK [QUICK2]:NG
```

- When the code is registered.  
→ The zone mode indicator flashes twice.
- When the code is not registered correctly  
→ The mode indicator slowly flashes once. Perform from step 9 again.
- When an input number is not correct  
→ Press **POWER ON** once then perform the operations from Step 9 again.

**12** Operate the device being used to check the operation.  
• If the device is operating, press **QUICK SELECT 1**.  
→ Go to step 13.  
• If the device is not operating, press **QUICK SELECT 2**.  
→ Go to step 14.



Registering preset codes

**13** The screen shown below is displayed, and registration of the preset code is completed.

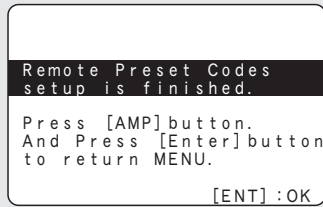

• The menu screen is retrieved. Press **AMP** then **ENTER**.

**14** Either of the screens below is displayed.

①

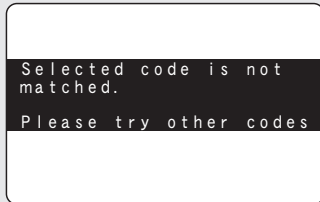

• The screen is displayed for 3 seconds, then the next preset registration screen is displayed automatically.

**[If screen ① is displayed]**

The device may be operating with the preset code displayed next. The preset registration screen is displayed. Repeat steps 9 to 12.

**[If screen ② is displayed]**

The device cannot be controlled with the remote control unit supplied with this unit. Use the remote control unit supplied with the device to be used. The menu screen is retrieved. Press **AMP** then **ENTER**.



Some manufacturers use more than one type of remote control code. Preset codes to change the number and verify correct operation.

**NOTE**

Depending on the model and year of manufacture of your equipment, some buttons may not operate.

Operating components

The supplied remote control unit can control a component other than this unit.

**1** Switch the input source (page 20).

**2** Operate the component.

• For details, refer to the component's operating instructions.



Blu-ray Disc player / HD-DVD player / DVD player / DVD recorder operation



Operation buttons	Function
<b>ZONE/DEVICE ON</b>	Power on *
<b>ZONE/DEVICE OFF</b>	Power standby *
<b>CH +, -</b>	Switch channels (up/down)
<b>MENU</b>	(Popup) Menu
<b>TOP MENU</b>	Top menu
$\Delta \nabla \triangleleft \triangleright$	Cursor operation
<b>ENTER</b>	Enter setting
<b>SETUP</b>	Setup
<b>RETURN</b>	Return
$\lll \ggg$	Manual search (fast-reverse/fast-forward)
$\blacktriangleright$	Playback
$\lll \blacktriangleright \ggg$	Auto search (cue)
<b>II</b>	Pause
$\blacksquare$	Stop
<b>0 - 9, +10</b>	Select title, chapter or channel selection
<b>TV POWER</b>	TV power on/standby (Default : SONY)
<b>TV INPUT</b>	Switch TV input (Default : SONY)

\* This may power some devices on/standby.

CD player / CD recorder operation



Operation buttons	Function
<b>ZONE/DEVICE ON</b>	Power on *
<b>ZONE/DEVICE OFF</b>	Power standby *
$\Delta \nabla \triangleleft \triangleright$	Cursor operation
<b>ENTER</b>	Enter setting
$\lll \ggg$	Manual search (fast-reverse/fast-forward)
$\blacktriangleright$	Playback
$\lll \blacktriangleright \ggg$	Auto search (cue)
<b>II</b>	Pause
$\blacksquare$	Stop
<b>0 - 9, +10</b>	Track selection
<b>TV POWER</b>	TV power on/standby (Default : SONY)
<b>TV INPUT</b>	Switch TV input (Default : SONY)

Digital video recorder (PVR) / video cassette recorder (VCR) operation



Operation buttons	Function
<b>ZONE/DEVICE ON</b>	Power on *
<b>ZONE/DEVICE OFF</b>	Power standby *
<b>CH +, -</b>	Switch channels (up/down)
<b>MENU</b>	Menu
$\Delta \nabla \triangleleft \triangleright$	Cursor operation
<b>ENTER</b>	Enter setting
<b>SETUP</b>	Setup
<b>RETURN</b>	Return
$\lll \ggg$	Manual search (fast-reverse/fast-forward)
$\blacktriangleright$	Playback
$\lll \blacktriangleright \ggg$	Auto search (cue)
<b>II</b>	Pause
$\blacksquare$	Stop
<b>0 - 9, +10</b>	Select title, chapter or channel selection
<b>TV POWER</b>	TV power on/standby (Default : SONY)
<b>TV INPUT</b>	Switch TV input (Default : SONY)

Operating components

TV operation



Operation buttons	Function
<b>ZONE/DEVICE ON</b>	Power on *
<b>ZONE/DEVICE OFF</b>	Power standby *
<b>CH +, -</b>	Switch channels (up/down)
<b>MENU</b>	Menu
△▽◀▶	Cursor operation
<b>SETUP</b>	Setup
<b>ENTER</b>	Enter setting
<b>RETURN</b>	Return
◀▶▶▶	Manual search (fast-reverse/fast-forward)
▶	Playback
◀▶▶▶	Auto search (cue)
⏸	Pause
■	Stop
<b>0 - 9, +10</b>	Channel selection
<b>TV POWER</b>	TV power on/standby (Default : SONY)
<b>TV INPUT</b>	Switch TV input (Default : SONY)

Set top box for satellite (SAT) / cable (CBL) / IP TV operation



Operation buttons	Function
<b>ZONE/DEVICE ON</b>	Power on *
<b>ZONE/DEVICE OFF</b>	Power standby *
<b>CH +, -</b>	Switch channels (up/down)
<b>MENU</b>	Menu
△▽◀▶	Cursor operation
<b>ENTER</b>	Enter setting
<b>RETURN</b>	Return
◀▶▶▶	Manual search (fast-reverse/fast-forward)
▶	Playback
◀▶▶▶	Auto search (cue)
⏸	Pause
■	Stop
<b>0 - 9, +10</b>	Channel selection
<b>TV POWER</b>	TV power on/standby (Default : SONY)
<b>TV INPUT</b>	Switch TV input (Default : SONY)

Specifying the zone used with the remote control unit

When the **ZONE SELECT** button is pressed, only the set zone can be operated with the remote control unit.

- 1 Press and hold POWER ON and ZONE/DEVICE ON for at least 3 seconds.**  
The zone mode indicator flashes twice.
- 2 Press ZONE SELECT.**  
The zone mode indicator flashes twice.
- 3 Press 1 - 3 to set.**  
The zone mode indicator flashes twice.

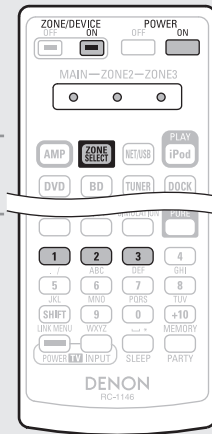

[Settable items]

- When only using "MAIN ZONE"
- When using "MAIN ZONE" / "ZONE2"
- When using "MAIN ZONE" / "ZONE2" / "ZONE3" (Default)

Resetting the remote control unit

Settings for the remote control unit are returned to the default setting.

- 1 Press and hold POWER ON and ZONE/DEVICE ON for at least 3 seconds.**  
The zone mode indicator flashes twice.
- 2 Press 9, 8 and 1, in that order.**  
"MAIN" indicator flashes four times.  
All the settings are restored to their defaults.

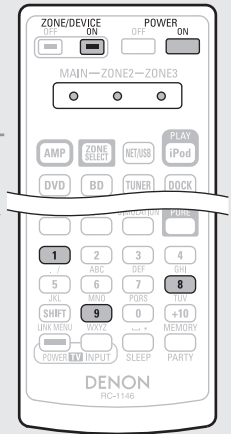





\* This may power some devices on/standby.

## Information

---

Here, we list various information related to this unit.  
Please refer to this information as needed.

- Part names and functions  page 65
- Other information  page 69
- Troubleshooting  page 76
- Specifications  page 78
- Index  page 79

# Part names and functions

## Front panel

For buttons not explained here, see the page indicated in parentheses ( ).

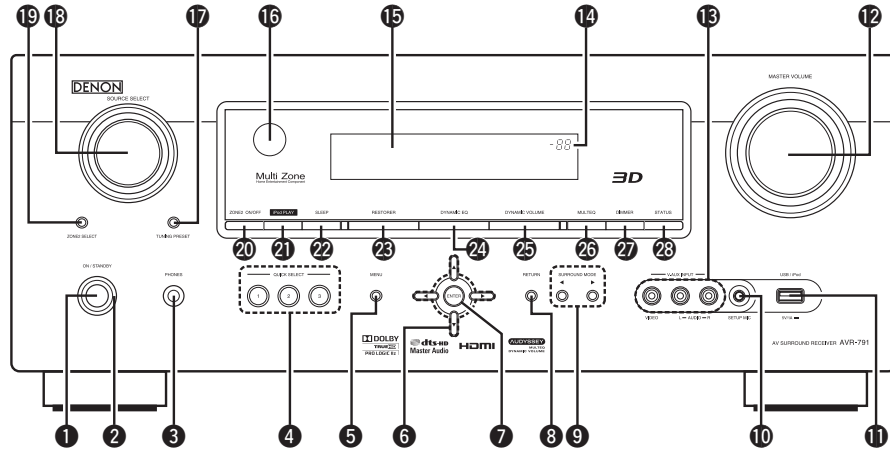

- 1 Power operation button (ON/STANDBY)** ..... (6, 11)  
Turns power to this unit on and off (standby).
  - 2 Power indicator** ..... (11)
  - 3 Headphones jack**  
When the headphones are plugged into this jack, audio will no longer be output from the connected speakers or from the PRE OUT connectors.
- NOTE**  
To prevent hearing loss, do not raise the volume level excessively when using headphones.
- 4 QUICK SELECT buttons** ..... (36, 38)
  - 5 MENU button** ..... (42)
  - 6 Cursor buttons (△▽◀▶)** ..... (40 – 42)
  - 7 ENTER button** ..... (40 – 42)
  - 8 RETURN button** ..... (40 – 42)
  - 9 SURROUND MODE buttons** ..... (26, 78)
  - 10 SETUP MIC jack** ..... (8, 33)
  - 11 USB/iPod port** ..... (18)
  - 12 MASTER VOLUME control knob** ..... (20)

- 13 V.AUX INPUT connectors** ..... (17)  
Remove the cap covering the connectors when you want to use them.

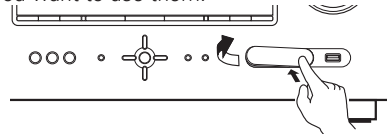

- 14 Master volume indicator** ..... (65)
- 15 Display** ..... (65)
- 16 Remote control sensor** ..... (68)
- 17 TUNING PRESET button** ..... (24)
- 18 SOURCE SELECT knob** ..... (20, 37)
- 19 ZONE2 SELECT button** ..... (37)
- 20 ZONE2 ON/OFF button** ..... (37)
- 21 iPod PLAY button** ..... (23)
- 22 Sleep timer button (SLEEP)** ..... (35)
- 23 RESTORER button** ..... (51)
- 24 DYNAMIC EQ® button** ..... (50)
- 25 DYNAMIC VOLUME™ button** ..... (50)
- 26 MULTEQ® button** ..... (49, 56)
- 27 DIMMER button** ..... (58)
- 28 STATUS button** ..... (58)

## Display

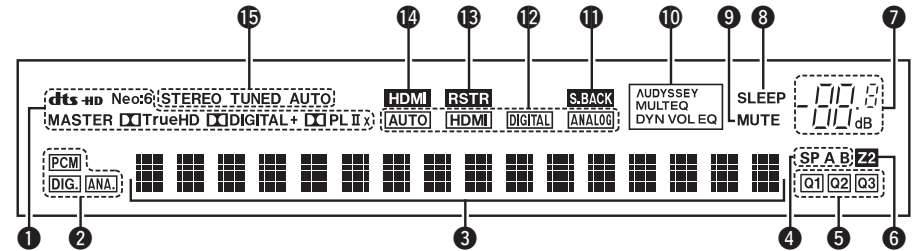

- 1 Decoder indicators**  
These light when the respective decoders are operating.
- 2 Input signal indicators**
- 3 Information display**  
The input source name, surround mode, setting values and other information are displayed here.
- 4 Front speaker indicator**  
Lights when audio signals are being output from the speakers.
- 5 QUICK SELECT indicators**  
The indicator corresponding to the memory for which Quick Select function is set, lights ("Quick select function" (page 36)).
- 6 ZONE2 indicator**  
This lights up when ZONE2 (separate room) power is turned on (page 37).
- 7 Master volume indicator**  
When performing setting operations, displays the menu number.
- 8 Sleep timer indicator**  
This lights when the sleep mode is selected (page 35).
- 9 MUTE indicator**  
This lights when the mute mode is selected (page 20).

- 10 AUDYSSEY MULTEQ indicators**  
Lighting is as follows, depending on the setting of "Dynamic EQ" (page 50) and "Dynamic Volume" (page 50).
- |                         |  |
|-------------------------|--|
| AUDYSSEY MULTEQ DYN VOL | When "Dynamic EQ" and "Dynamic Volume" are "ON".         |
| AUDYSSEY MULTEQ DYN EQ  | When "Dynamic EQ" is "ON" and "Dynamic Volume" is "OFF". |
| AUDYSSEY MULTEQ         | When "Dynamic EQ" and "Dynamic Volume" are "OFF".        |

- 11 Surround back indicator**  
Lights when audio signals are being output from the surround back speakers (page 53).
- 12 Input mode indicators**  
Set the audio input modes for the different input sources (page 46).
- 13 RESTORER indicator**  
This lights when the RESTORER mode is selected (page 51).
- 14 HDMI indicator**  
This lights when playing using HDMI connections.
- 15 Tuner reception mode indicators**  
These light according to the reception conditions when the input source is set to "TUNER".  
**STEREO:** In the FM mode, this light when receiving analog stereo broadcasts.  
**TUNED:** Lights when the broadcast is properly tuned in.  
**AUTO:** This light when in the auto tuning mode.

# Rear panel

See the page indicated in parentheses ( ).

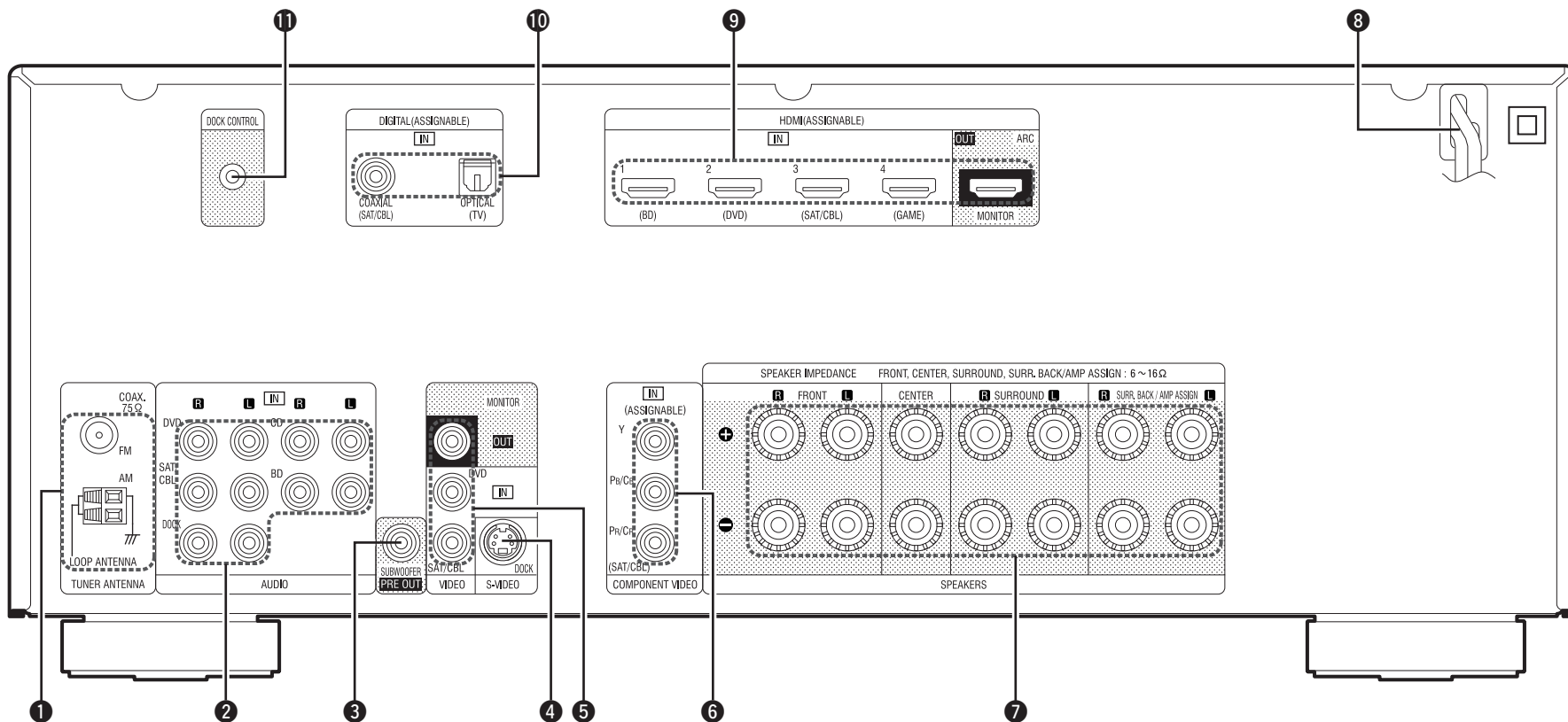

- ① FM/AM antenna terminals ..... (19)
- ② Analog audio connectors ..... (16 – 19)
- ③ PRE OUT connector ..... (5, 31, 32)
- ④ S-VIDEO connector ..... (18)
- ⑤ VIDEO connectors ..... (16, 17)
- ⑥ COMPONENT VIDEO connectors ..... (17)
- ⑦ Speaker terminals ..... (5, 31, 32)
- ⑧ Power cord ..... (5)
- ⑨ HDMI connectors ..... (15)
- ⑩ Digital audio connectors ..... (16, 17)
- ⑪ DOCK CONTROL jack ..... (18)

**NOTE**

- Do not touch the inner pins of the connectors on the rear panel. Electrostatic discharge may cause permanent damage to the unit.
- Do not put your finger or foreign object in the fan opening. Doing so could cause injury or unit failure.

# Remote control unit

For buttons not explained here, see the page indicated in parentheses ( ).

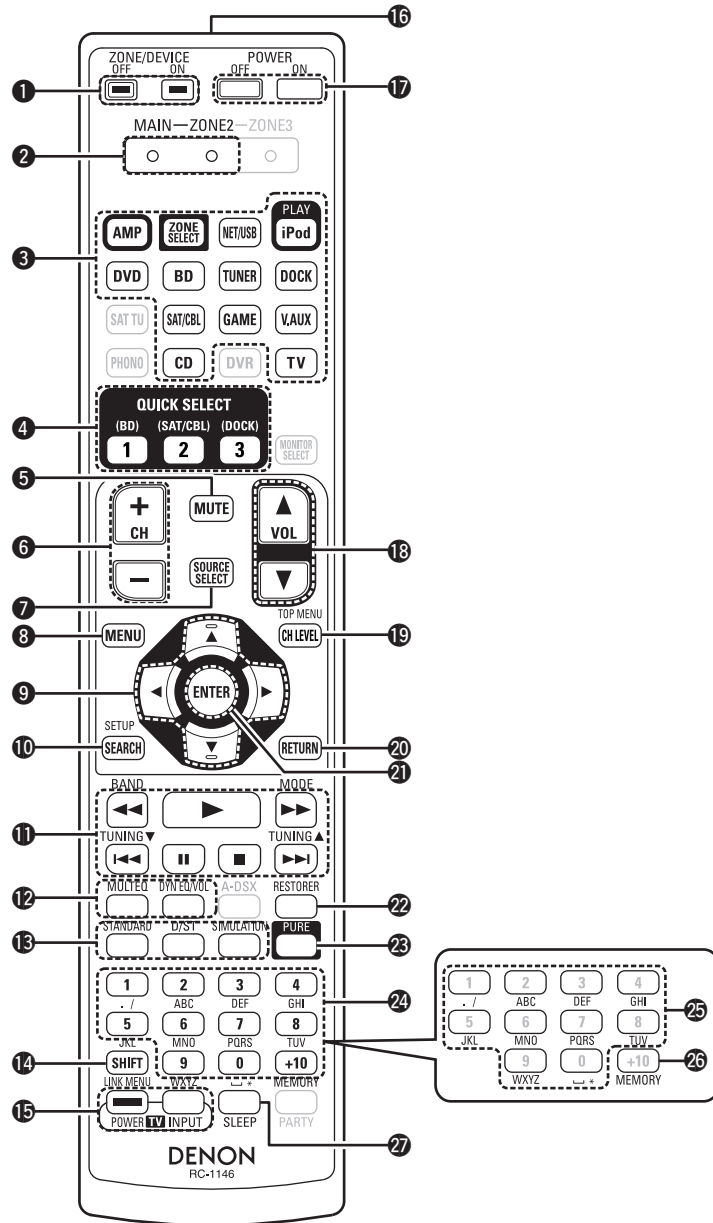

- 1 ZONE/DEVICE power buttons ..... (37, 60)
- 2 Zone mode indicators ..... (37, 60)
- 3 Input source select buttons ..... (20, 37)
- 4 QUICK SELECT buttons ..... (36, 38)
- 5 Muting button (MUTE) ..... (20, 37)
- 6 Channel buttons (CH) ..... (24, 62)
- 7 SOURCE SELECT button ..... (20, 37)
- 8 MENU button ..... (42)
- 9 Cursor buttons (▲▼◀▶) ..... (40 – 42)
- 10 SEARCH button ..... (21, 42)
- 11 System buttons ..... (21 – 23, 62)
  - Skip button (◀◀▶▶▶)
  - Play button (▶)
  - Search button (◀◀▶▶▶)
  - Pause button (⏸)
  - Stop button (■)
- Tuner system buttons ..... (24)
  - FM/AM band switching button (BAND)
  - Tuning mode button (MODE)
  - Tuning down / Tuning up button (TUNING ▲▼)
- 12 Audyssey buttons ..... (49, 50, 56)
  - MULTEQ® button
  - Dynamic EQ®/Dynamic Volume™ button (DYN EQ/VOL)
- 13 Surround mode buttons ..... (26)
  - STANDARD button
  - Direct / Stereo button (D/ST)
  - DSP simulation button (SIMULATION)
- 14 SHIFT button ..... (24, 41)
- 15 TV operation buttons (TV POWER / INPUT) ..... (63)
- 16 Remote control signal transmitter ..... (68)
- 17 Power buttons (POWER ON / OFF) ..... (6, 11)
- 18 Master volume control buttons (VOL) ..... (20)
- 19 Channel level button (CH LEVEL) ..... (35)
- 20 RETURN button ..... (40 – 42)
- 21 ENTER button ..... (40 – 42)
- 22 RESTORER button ..... (51)
- 23 Pure direct button (PURE) ..... (28)
- 24 Number buttons ..... (24, 62, 63)
- 25 Character buttons ..... (41)
- 26 MEMORY button ..... (24)
- 27 Sleep timer button (SLEEP) ..... (35)

**NOTE**

- NET/USB switches to the source of an iPod or USB memory device connected via the USB port of this unit. For network connection of this unit, connect a control dock for iPod ASD-3N/ASD-3W/ASD-51N/ASD-51W (sold separately) to this unit to use the network function of the control dock for iPod.
- The SAT TU, PHONO, DVR, MONITOR SELECT, A-DSX and PARTY buttons cannot be used.

Simple version

Basic version

Advanced version

Information

## Remote control unit

**Inserting the batteries**

- ① Slide the rear lid in the direction of the arrow and remove it.

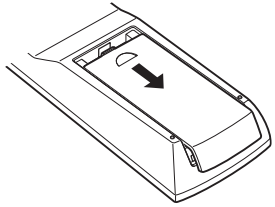

- ② Load the two batteries properly as indicated by the marks in the battery compartment.

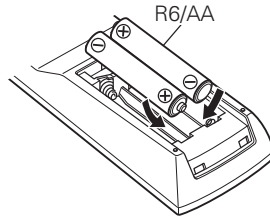

- ③ Put the rear cover back on.

**NOTE**

- Insert the specified batteries in the remote control unit.
- Replace the batteries with new ones if the set does not operate even when the remote control unit is operated close to the unit. (The supplied batteries are only for verifying operation.)
- When inserting the batteries, be sure to do so in the proper direction, following the ⊕ and ⊖ marks in the battery compartment.
- To prevent damage or leakage of battery fluid:
  - Do not use a new battery together with an old one.
  - Do not use two different types of batteries.
  - Do not attempt to charge dry batteries.
  - Do not short-circuit, disassemble, heat or dispose of batteries in flames.
- If the battery fluid should leak, carefully wipe the fluid off the inside of the battery compartment and insert new batteries.
- Remove the batteries from the remote control unit if it will not be in use for long periods.
- Used batteries should be disposed of in accordance with the local regulations regarding battery disposal.

**Operating range of the remote control unit**

Point the remote control unit at the remote sensor when operating it.

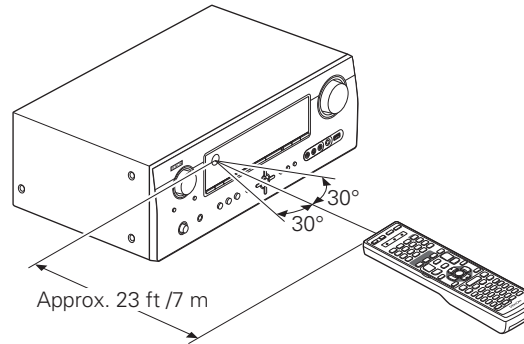
**NOTE**





The set may function improperly or the remote control unit may not operate if the remote control sensor is exposed to direct sunlight, strong artificial light from an inverter type fluorescent lamp or infrared light.

# Other information

- ❑ **Trademark information** (👉 page 69)
- ❑ **Surround** (👉 page 70)
- ❑ **Explanation of terms** (👉 page 74)

## Trademark information

This product uses the following technologies:

	<p>Manufactured under license from Dolby Laboratories. “Dolby”, “Pro Logic” and the double-D symbol are trademarks of Dolby Laboratories.</p>
	<p>Manufactured under license under U.S. Patent #'s: 5,451,942; 5,956,674; 5,974,380; 5,978,762; 6,226,616; 6,487,535; 7,212,872; 7,333,929; 7,392,195; 7,272,567 &amp; other U.S. and worldwide patents issued &amp; pending. DTS and the Symbol are registered trademarks, &amp; DTS-HD, DTS-HD Master Audio, and the DTS logos are trademarks of DTS, Inc. Product includes software. © DTS, Inc. All Rights Reserved.</p>
	<p>HDMI, the HDMI logo and High-Definition Multimedia Interface are trademarks or registered trademarks of HDMI Licensing LLC in the United States and other countries.</p>
	<p>Manufactured under license from Audyssey Laboratories™. U.S. and foreign patents pending. Audyssey MultEQ® is a registered trademark of Audyssey Laboratories. Audyssey Dynamic EQ® is a registered trademark of Audyssey Laboratories. Audyssey Dynamic Volume™ is a trademark of Audyssey Laboratories.</p>



“Made for iPod” means that an electronic accessory has been designed to connect specifically to iPod and has been certified by the developer to meet Apple performance standards.

“Works with iPhone” means that an electronic accessory has been designed to connect specifically to iPhone and has been certified by the developer to meet Apple performance standards.

Apple is not responsible for the operation of this device or its compliance with safety and regulatory standards.

iPod is a trademark of Apple Inc., registered in the U.S. and other countries. iPhone is a trademark of Apple Inc.

- The iPod may only be used to copy or play content that are not copyrighted or content for which copying or playback is legally permitted for your private use as an individual. Be sure to comply with applicable copyright legislation.

Simple version

Basic version

Advanced version

Information



# Surround

This unit is equipped with a digital signal processing circuit that lets you play program sources in the surround mode to achieve the same sense of presence as in a movie theater.

## Surround modes and surround parameters

This table shows the speakers that can be used in each surround mode and the surround parameters adjustable in each surround mode.

### Symbols in the table

- This indicates the audio output channels or surround parameters that can be set.
- ◎ This indicates the audio output channels. The output channels depend on the settings of "Speaker Config." (page 52).

Surround mode (page 26)	Channel output						Surround Parameter (page 47)							
	Front L/R	Center	Surround L/R	Surround Back L/R	Front Height L/R	Subwoofer	Mode (page 47)	Cinema EQ. *5 (page 47)	DRC *9 (page 47)	D. Comp *10 (page 47)	LFE *11 (page 47)	Delay Time (page 48)	Effect Lev. (page 48)	Room Size (page 48)
PURE DIRECT	○					◎*3			○	○	○			
DIRECT (2channel)	○					◎*3			○	○				
DIRECT (Multi-channel)	○	◎	◎	◎*1	◎*1	◎			○	○	○			
STEREO	○					◎			○	○	○			
MULTI CH IN	○	◎	◎	◎	◎*2	◎		○			○			
DOLBY PRO LOGIC IIz	○	◎	◎		◎	◎	○*4	○	○	○				
DOLBY PRO LOGIC IIx	○	◎	◎	◎		◎	○	○*6	○	○				
DOLBY PRO LOGIC II	○	◎	◎			◎	○	○*7	○	○				
DTS NEO:6	○	◎	◎	◎		◎	○	○*6	○	○				
DOLBY DIGITAL	○	◎	◎	◎	◎*2	◎		○*8		○	○			
DOLBY DIGITAL Plus	○	◎	◎	◎	◎*2	◎		○*8		○	○			
DOLBY TrueHD	○	◎	◎	◎	◎*2	◎		○*8	○		○			
DTS SURROUND	○	◎	◎	◎	◎*2	◎		○*8		○	○			
DTS 96/24	○	◎	◎	◎	◎*2	◎		○*8		○	○			
DTS-HD	○	◎	◎	◎	◎*2	◎		○*8		○	○			
DTS Express	○	◎	◎	◎	◎*2	◎		○*8		○	○			
MULTI CH STEREO	○	◎	◎	◎	◎*2	◎				○	○			
ROCK ARENA	○	◎	◎	◎	◎*2	◎				○	○		○	○
JAZZ CLUB	○	◎	◎	◎	◎*2	◎				○	○		○	○
MONO MOVIE	○	◎	◎	◎	◎*2	◎				○	○		○	○
VIDEO GAME	○	◎	◎	◎	◎*2	◎				○	○		○	○
MATRIX	○	◎	◎	◎	◎*2	◎				○	○	○		
VIRTUAL	○					◎*3				○	○			

- \*1 A signal for each channel contained in an input signal is output as audio.
- \*2 If "Surround Parameter" – "Front Height" (page 48) is set to "ON", sound is output from the front height speakers.
- \*3 Only when "Subwoofer Mode" is set to "LFE+Main" (page 53), sound is output from the subwoofer.
- \*4 If this surround mode is selected, only the "Height" mode setting is available for "Surround Parameter" – "Mode" (page 47).
- \*5 For HD Audio whose sampling frequency of an input signal is more than 96kHz, this sound parameter cannot be set.
- \*6 This item can be selected when "Surround Parameter" – "Mode" (page 47) is set to "Cinema".
- \*7 This item can be selected when "Surround Parameter" – "Mode" (page 47) is set to "Cinema" or "Pro Logic".
- \*8 This item cannot be set when "Surround Parameter" – "S.Back" (page 48) is set to "PLIIx Music".
- \*9 This item can be selected when a Dolby TrueHD signal is played.
- \*10 This item can be selected when a Dolby Digital or DTS signal is played.
- \*11 This item can be selected when a Dolby Digital or DTS signal or DVD-Audio is played.

Surround mode (page 26)	Surround Parameter (page 47)									Tone * 15 (page 49)	Audyssey Settings * 20 (page 49)			RESTORER * 19 (page 51)
	AFDM * 12 (page 48)	S.Back (page 48)	Front Height * 13 (page 48)	Height Gain (page 49)	Subwoofer (page 49)	PRO LOGIC II/IIx Music mode only			NEO:6 Music mode only		MultEQ® (page 49)	Dynamic EQ® * 17 (page 50)	Dynamic Volume™ * 18 (page 50)	
						Panorama (page 48)	Dimension (page 48)	Center Width (page 48)						
PURE DIRECT					<input type="radio"/> * 3									
DIRECT (2 channel)					<input type="radio"/> * 3									
DIRECT (Multi-channel)														
STEREO									<input type="radio"/>	<input type="radio"/>	<input type="radio"/>	<input type="radio"/>	<input type="radio"/>	
MULTI CH IN	<input type="radio"/>	<input type="radio"/>	<input type="radio"/>	<input type="radio"/> * 14					<input type="radio"/>	<input type="radio"/>	<input type="radio"/>	<input type="radio"/>	<input type="radio"/>	
DOLBY PRO LOGIC IIz			<input type="radio"/>	<input type="radio"/>					<input type="radio"/>	<input type="radio"/>	<input type="radio"/>	<input type="radio"/>	<input type="radio"/>	
DOLBY PRO LOGIC IIx		<input type="radio"/>				<input type="radio"/>	<input type="radio"/>	<input type="radio"/>	<input type="radio"/>	<input type="radio"/>	<input type="radio"/>	<input type="radio"/>	<input type="radio"/>	
DOLBY PRO LOGIC II		<input type="radio"/>	<input type="radio"/>			<input type="radio"/>	<input type="radio"/>	<input type="radio"/>	<input type="radio"/>	<input type="radio"/>	<input type="radio"/>	<input type="radio"/>	<input type="radio"/>	
DTS NEO:6		<input type="radio"/>						<input type="radio"/>	<input type="radio"/>	<input type="radio"/>	<input type="radio"/>	<input type="radio"/>	<input type="radio"/>	
DOLBY DIGITAL	<input type="radio"/>	<input type="radio"/>	<input type="radio"/>	<input type="radio"/> * 14					<input type="radio"/>	<input type="radio"/>	<input type="radio"/>	<input type="radio"/>	<input type="radio"/>	
DOLBY DIGITAL Plus	<input type="radio"/>	<input type="radio"/>	<input type="radio"/>	<input type="radio"/> * 14					<input type="radio"/>	<input type="radio"/>	<input type="radio"/>	<input type="radio"/>	<input type="radio"/>	
DOLBY TrueHD	<input type="radio"/>	<input type="radio"/>	<input type="radio"/>	<input type="radio"/> * 14					<input type="radio"/>	<input type="radio"/>	<input type="radio"/>	<input type="radio"/>	<input type="radio"/>	
DTS SURROUND	<input type="radio"/>	<input type="radio"/>	<input type="radio"/>	<input type="radio"/> * 14					<input type="radio"/>	<input type="radio"/>	<input type="radio"/>	<input type="radio"/>	<input type="radio"/>	
DTS 96/24	<input type="radio"/>	<input type="radio"/>	<input type="radio"/>	<input type="radio"/> * 14					<input type="radio"/>	<input type="radio"/>	<input type="radio"/>	<input type="radio"/>	<input type="radio"/>	
DTS-HD	<input type="radio"/>	<input type="radio"/>	<input type="radio"/>	<input type="radio"/> * 14					<input type="radio"/>	<input type="radio"/>	<input type="radio"/>	<input type="radio"/>	<input type="radio"/>	
DTS Express	<input type="radio"/>	<input type="radio"/>	<input type="radio"/>	<input type="radio"/> * 14					<input type="radio"/>	<input type="radio"/>	<input type="radio"/>	<input type="radio"/>	<input type="radio"/>	
MULTI CH STEREO		<input type="radio"/>	<input type="radio"/>						<input type="radio"/>	<input type="radio"/>	<input type="radio"/>	<input type="radio"/>	<input type="radio"/>	
ROCK ARENA		<input type="radio"/>	<input type="radio"/>						<input type="radio"/> * 16	<input type="radio"/>	<input type="radio"/>	<input type="radio"/>	<input type="radio"/>	
JAZZ CLUB		<input type="radio"/>	<input type="radio"/>						<input type="radio"/>	<input type="radio"/>	<input type="radio"/>	<input type="radio"/>	<input type="radio"/>	
MONO MOVIE		<input type="radio"/>	<input type="radio"/>						<input type="radio"/>	<input type="radio"/>	<input type="radio"/>	<input type="radio"/>	<input type="radio"/>	
VIDEO GAME		<input type="radio"/>	<input type="radio"/>						<input type="radio"/>	<input type="radio"/>	<input type="radio"/>	<input type="radio"/>	<input type="radio"/>	
MATRIX		<input type="radio"/>	<input type="radio"/>						<input type="radio"/>	<input type="radio"/>	<input type="radio"/>	<input type="radio"/>	<input type="radio"/>	
VIRTUAL									<input type="radio"/>	<input type="radio"/>	<input type="radio"/>	<input type="radio"/>	<input type="radio"/>	

- \* 3 Only when "Subwoofer Mode" is set to "LFE+Main" (page 53), sound is output from the subwoofer.
- \* 12 This item can be selected when a Dolby Digital or DTS or DVD-Audio signal is played.
- \* 13 If "Speaker Config." - "Front Height" (page 53) is set to "None", this item cannot be selected.
- \* 14 This item can be selected when "Surround Parameter" - "Front Height" (page 48) is set to "ON".
- \* 15 This item cannot be set when "Dynamic EQ" (page 50) is set to "ON".
- \* 16 In this surround mode, bass is +6 dB, and treble is +4 dB. (Default)
- \* 17 This item cannot be set when "MultEQ" (page 49) is set to "OFF" or "Manual".
- \* 18 This item cannot be set when "Dynamic EQ" (page 50) is set to "OFF".
- \* 19 This item can be set when the input signal is analog, PCM 48 kHz or 44.1 kHz.
- \* 20 For HD Audio whose sampling frequency of an input signal is more than 96 kHz, this sound parameter cannot be set.

Simple version

Basic version

Advanced version

Information

Surround

Types of input signals, and corresponding surround modes

This table shows the input signal that can be played in each surround mode. Check the audio signal of the input source then select the surround mode.

Symbols in the table

- This indicates the default surround mode.
- ⊙ This indicates the surround mode that is fixed when "AFDM" (page 48) is set to "ON".
- This indicates the selectable surround mode.

Surround mode (page 26)	NOTE	Input signal types and formats																
		ANALOG	PCM		DTS-HD		DTS					DOLBY		DOLBY DIGITAL				
			LINEAR PCM (multi ch)	LINEAR PCM (2ch)	DTS-HD Master Audio	DTS-HD High Resolution Audio	DTS EXPRESS	DTS ES DSCRT (With Flag)	DTS ES MTRX (With Flag)	DTS (5.1ch)	DTS 96/24	DOLBY TrueHD	DOLBY DIGITAL Plus	DOLBY DIGITAL EX (With Flag)	DOLBY DIGITAL EX (With no Flag)	DOLBY DIGITAL (5.1/5/4ch)	DOLBY DIGITAL (4/3ch)	DOLBY DIGITAL (2ch)
<b>DTS SURROUND</b>																		
DTS-HD MSTR					●													
DTS-HD HI RES						●												
DTS ES DSCRT6.1	* 1 * 3								● ⊙									
DTS ES MTRX6.1	* 1 * 3								● ⊙									
DTS SURROUND									○	○	●							
DTS 96/24												●						
DTS (-HD) + PLIIx CINEMA	* 2 * 3				○	○	○	○	○	○	○	○						
DTS (-HD) + PLIIx MUSIC	* 1 * 3				○	○	○	○	○	○	○	○						
DTS (-HD) + PLIIz	* 4				○	○	○	○	○	○	○	○						
DTS EXPRESS								●										
DTS (-HD) + NEO:6	* 1 * 3				○	○	○		○	○	○							
DTS NEO:6 CINEMA		○		○													○	
DTS NEO:6 MUSIC		○		○													○	
<b>DOLBY SURROUND</b>																		
DOLBY TrueHD													●					
DOLBY DIGITAL+														●				
DOLBY DIGITAL EX	* 1 * 3													○	○	○		
DOLBY (D+) (HD) +EX	* 1 * 3												○	○				
DOLBY DIGITAL														○	●	●	●	
DOLBY (D) (D+) (HD) +PLIIx CINEMA	* 2 * 3													○	○	○	○	
DOLBY (D) (D+) (HD) +PLIIx MUSIC	* 1 * 3													○	○	○	○	
DOLBY (D) (D+) (HD) +PLIIz	* 4													○	○	○	○	
DOLBY PRO LOGIC IIx CINEMA	* 1 * 3	○		○														○
DOLBY PRO LOGIC IIx MUSIC	* 1 * 3	○		○														○
DOLBY PRO LOGIC IIx GAME	* 1 * 3	○		○														○
DOLBY PRO LOGIC IIz	* 4	○		○														○
DOLBY PRO LOGIC II CINEMA		○		○														○
DOLBY PRO LOGIC II MUSIC		○		○														○
DOLBY PRO LOGIC II GAME		○		○														○
DOLBY PRO LOGIC		○		○														○

\* 1 If "Speaker Config." - "S.Back" (page 53) is set to "None", this surround mode cannot be selected.  
 \* 2 If "Speaker Config." - "S.Back" (page 53) is set to "1sp" or "None", this surround mode cannot be selected.  
 \* 3 This surround mode can be selected when "Amp Assign" (page 52) is set to "Normal".  
 \* 4 If "Speaker Config." - "Front Height" (page 53) is set to "None", this surround mode cannot be selected.

Surround mode (🔗 page 26)	NOTE	Input signal types and formats																
		ANALOG	PCM		DTS-HD		DTS					DOLBY		DOLBY DIGITAL				
			LINEAR PCM (multi ch)	LINEAR PCM (2ch)	DTS-HD Master Audio	DTS-HD High Resolution Audio	DTS EXPRESS	DTS ES DSCRT (With Flag)	DTS ES MTRX (With Flag)	DTS (5.1ch)	DTS 96/24	DOLBY TrueHD	DOLBY DIGITAL Plus	DOLBY DIGITAL EX (With Flag)	DOLBY DIGITAL EX (With no Flag)	DOLBY DIGITAL (5.1/5/4ch)	DOLBY DIGITAL (4/3ch)	DOLBY DIGITAL (2ch)
MULTI CH IN																		
MULTI CH IN			●															
MULTI CH IN + PLIIx CINEMA	* 2 * 3		○															
MULTI CH IN + PLIIx MUSIC	* 1 * 3		○															
MULTI CH IN + PLIIz	* 4		○															
MULTI CH IN + Dolby EX	* 1 * 3		○															
MULTI CH IN 7.1	* 3		● ◎ (7.1)															
DIRECT																		
DIRECT		○	○	○	○	○	○	○	○	○	○	○	○	○	○	○	○	○
PURE DIRECT																		
PURE DIRECT		○	○	○	○	○	○	○	○	○	○	○	○	○	○	○	○	○
DSP SIMULATION																		
MULTI CH STEREO		○	○	○				○	○	○	○			○	○	○	○	○
ROCK ARENA		○	○	○				○	○	○	○			○	○	○	○	○
JAZZ CLUB		○	○	○				○	○	○	○			○	○	○	○	○
MONO MOVIE		○	○	○				○	○	○	○			○	○	○	○	○
VIDEO GAME		○	○	○				○	○	○	○			○	○	○	○	○
MATRIX		○	○	○				○	○	○	○			○	○	○	○	○
VIRTUAL		○	○	○				○	○	○	○			○	○	○	○	○
STEREO																		
STEREO		●	○	●	○	○	○	○	○	○	○	○	○	○	○	○	○	○

- \* 1 If "Speaker Config." - "S.Back" (🔗 page 53) is set to "None", this surround mode cannot be selected.
- \* 2 If "Speaker Config." - "S.Back" (🔗 page 53) is set to "1sp" or "None", this surround mode cannot be selected.
- \* 3 This surround mode can be selected when "Amp Assign" (🔗 page 52) is set to "Normal".
- \* 4 If "Speaker Config." - "Front Height" (🔗 page 53) is set to "None", this surround mode cannot be selected.

Simple version

Basic version

Advanced version

Information

## Explanation of terms

### A

#### Adobe RGB color / Adobe YCC601 color

Like x.v.Color, each of these color spaces defines a palette of available colors that is larger than the traditional RGB color model, and closer to the full range of colors perceptible to the human eye.

#### Audyssey Dynamic EQ®

Audyssey Dynamic EQ solves the problem of deteriorating sound quality as volume is decreased by taking into account human perception and room acoustics. Audyssey Dynamic EQ works in tandem with Audyssey MultEQ® to provide well-balanced sound for every listener at any volume level.

#### Audyssey Dynamic Volume™

Audyssey Dynamic Volume solves the problem of large variations in volume level between television programs, commercials, and between the soft and loud passages of movies. Audyssey Dynamic EQ is integrated into Dynamic Volume so that as the playback volume is adjusted automatically, the perceived bass response, tonal balance, surround impression, and dialog clarity remain the same.

#### Audyssey MultEQ®

Audyssey MultEQ is a room equalization solution that calibrates any audio system so that it can achieve optimum performance for every listener in a large listening area. Based on several room measurements, MultEQ calculates an equalization solution that corrects for both time and frequency response problems in the listening area and also performs a fully automated surround system setup.

#### Auto Lip Sync

If you connect the receiver to a TV that supports the Auto Lip Sync function, it can automatically correct delay between the audio and video.

### D

#### Deep Color

This technology allows expression of more number of colors than the conventional 8 bits and can reproduce colors close to natural ones without color streak.

#### Dolby Digital

Dolby Digital is a multi-channel digital signal format developed by Dolby Laboratories.

A total of 5.1 channels are played: 3 front channels ("FL" , "FR" and "C"), 2 surround channels ("SL" and "SR") and the "LFE" channel for low frequencies.

Because of this, there is no crosstalk between channels and a realistic sound field with a "three-dimensional" feeling (sense of distance, movement and positioning) is achieved.

A realistic, powerful sense of presence is achieved when playing movie sources in AV rooms as well.

#### Dolby Digital EX

Dolby Digital EX is a 6.1-channel surround format proposed by Dolby Laboratories that allows users to enjoy in their homes the "DOLBY DIGITAL SURROUND EX" audio format jointly developed by Dolby Laboratories and Lucas Films.

The 6.1 channels of sound, including surround back channels, provide improved sound positioning and expression of space.

#### Dolby Digital Plus

Dolby Digital Plus is an improved Dolby Digital signal format that is compatible with up to 7.1 channels of discrete digital sound and also improves sound quality thanks to extra data bit rate performance. It is upwardly compatible with conventional Dolby Digital, so it offers greater flexibility in response to the source signal and the conditions of the playback equipment.

#### Dolby TrueHD

Dolby TrueHD is a high definition audio technology developed by Dolby Laboratories, using lossless coding technology to faithfully reproduce the sound of the studio master.

This format is compatible with a maximum sampling frequency of 96 kHz and up to 7.1 channels, so it is used for applications particularly prioritizing sound quality.

#### Dolby Pro Logic II

Dolby Pro Logic II is a matrix decoding technology developed by Dolby Laboratories.

Regular music such as that on CDs is encoded into 5 channels to achieve an excellent surround effect. The surround channel signals are converted into stereo and full band signals (with a frequency response of 20 Hz to 20 kHz or greater) to create a "three-dimensional" sound image offering a rich sense of presence for all stereo sources.

#### Dolby Pro Logic IIx

Dolby Pro Logic IIx is a further improved version of the Dolby Pro Logic II matrix decoding technology. Audio signals recorded in 2 channels are decoded to achieve a natural sound with up to 7.1 channels. There are three modes: "Music" suited for playing music, "Cinema" suited for playing movies, and "Game" which is optimized for playing games.

#### Dolby Pro Logic IIz

Dolby Pro Logic IIz introduces a new dimension to Home Entertainment through the addition of a pair of front height channels. Compatible with stereo, 5.1-channel and 7.1-channel content, Dolby Pro Logic IIz provides enhanced spaciousness, depth and dimension to movies, concert video and video game playback while maintaining the full integrity of the source mix.

Dolby Pro Logic IIz identifies and decodes spatial cues that occur naturally in all content, directing this information to the front height channels, complementing the performance of left and right surround sound speakers. Content that is encoded with Dolby Pro Logic IIz height channel information can be even more revealing, with perceptually discrete height channel information bringing an exciting new dimension to home entertainment. Dolby Pro Logic IIz, with front height channels is also an ideal alternative for households that cannot support the placement of back surround speakers of a typical 7.1-channel system but may have bookshelf space available to support the addition of height speakers.

#### Downmix

This function converts the number of channels of surround audio to less number of channels and plays back.

#### DTS

This is an abbreviation of Digital Theater System, which is a digital audio system developed by DTS. When playing back audio by connecting this system with a device such as DTS amplifier, accurate sound field position and realistic sound effect as if you are in a movie theater can be obtained.

#### DTS 96/24

DTS 96/24 is a digital audio format enabling high sound quality playback in 5.1 channels with a sampling frequency of 96 kHz and 24 bit quantization on DVD-Video.

#### DTS Digital Surround

DTS Digital Surround is the standard digital surround format of DTS, Inc., compatible with a sampling frequency of 44.1 or 48 kHz and up to 5.1 channels of digital discrete surround sound.

#### DTS-ES™ Discrete 6.1

DTS-ES™ Discrete 6.1 is a 6.1-channel discrete digital audio format adding a surround back (SB) channel to the DTS digital surround sound.

Decoding of conventional 5.1-channel audio signals is also possible according to the decoder.

#### DTS-ES™ Matrix 6.1

DTS-ES™ Matrix 6.1 is a 6.1-channel discrete digital audio format inserting a surround back (SB) channel to the DTS digital surround sound through matrix encoding. Decoding of conventional 5.1-channel audio signals is also possible according to the decoder.

#### DTS Express

DTS Express is an audio format supporting low bit rates (max. 5.1 channels, 24 to 256 kbps).

#### DTS-HD

This audio technology provides higher sound quality and enhanced functionality than the conventional DTS and is adopted as an optional audio for Blu-ray Disc. This technology supports multi-channel, high data transfer speed, high sampling frequency, and lossless audio playback. Maximum 7.1-channels are supported in Blu-ray Disc.

#### DTS-HD High Resolution Audio

DTS-HD High Resolution Audio is an improved version of the conventional DTS, DTS-ES and DTS 96/24 signals formats, compatible with sampling frequencies of 96 or 48 kHz and up to 7.1 channels of discrete digital sound. High data bit rate performance provides high quality sound. This format is fully compatible with conventional products, including conventional DTS digital surround 5.1-channel data.

#### DTS-HD Master Audio

DTS-HD Master Audio is DTS, Inc's lossless audio format compatible with up to 96 kHz/7.1 channels. The lossless audio coding technology faithfully reproduces the sound of the studio master. It is fully compatible with conventional products, including conventional DTS digital surround 5.1-channel data.

**DTS NEO:6™ Surround**

DTS NEO:6™ is a matrix decoding technology for achieving 6.1-channel surround playback with 2-channel sources. It includes “DTS NEO:6 Cinema” suited for playing movies and “DTS NEO:6 Music” suited for playing music.

**Dynamic range**

The difference between the maximum undistorted sound level and the minimum sound level that is discernible above the noise emitted by the device.

**H****HDCP**

When transmitting digital signals between devices, this copyright protection technology encrypts the signals to prevent content from being copied without authorization.

**HDMI**

This is an abbreviation of High-Definition Multimedia Interface, which is an AV digital interface that can be connected to a TV or amplifier. Video signal and audio signal can be connected using 1 cable.

**L****LFE**

This is an abbreviation of Low Frequency Effect, which is an output channel that emphasizes low frequency effect sound. Surround audio is intensified by outputting 20 Hz to 120 Hz deep bass.

**M****MAIN ZONE**

The room where this unit is placed is called the MAIN ZONE.

**MP3 (MPEG Audio Player 3)**

This is an internationally standardized audio data compression scheme, using the “MPEG-1” video compression standard. It compresses the data volume to about one eleventh its original size while maintaining sound quality equivalent to a music CD.

**MPEG (Moving Picture Experts Group), MPEG-2, MPEG-4**

These are the names for digital compression format standards used for the encoding of video and audio. Video standards include “MPEG-1 Video”, “MPEG-2 Video”, “MPEG-4 Visual”, “MPEG-4 AVC”. Audio standards include “MPEG-1 Audio”, “MPEG-2 Audio”, “MPEG-4 AAC”.

**P****Progressive (sequential scanning)**

This is a scanning system of video signal that displays 1 frame of video as one image. Compared to the interlace system, this system provides images with less flickering and bleeding.

**Protection Circuit**

This is a function to prevent damage to components within the power supply when an abnormality such as an overload, excess voltage occurs or temperature for any reason.

In this unit, the power indicator blinks and the unit enters standby mode when an abnormality occurs.

**S****Sampling frequency**

Sampling involves taking a reading of a sound wave (analog signal) at regular intervals and expressing the height of the wave at each reading in digitized format (producing a digital signal).

The number of readings taken in one second is called the “sampling frequency”. The larger the value, the closer the reproduced sound is to the original.

**S/PDIF**

One of the standards for digital transmission of audio signals.

**Speaker impedance**

This is an AC resistance value, indicated in  $\Omega$  (ohms). Greater power can be obtained with this value smaller.

**sYCC601 color**

Like x.v.Color, each of these color spaces defines a palette of available colors that is larger than the traditional RGB color model, and closer to the full range of colors perceptible to the human eye.

**W****WMA (Windows Media Audio)**

This is audio compression technology developed by Microsoft Corporation.

WMA data can be encoded using Windows Media® Player Ver.7, 7.1, Windows Media® Player for Windows® XP and Windows Media® Player 9 Series.

To encode WMA files, only use applications authorized by Microsoft Corporation. If you use an unauthorized application, the file may not work properly.

**X****x.v.Color**

This function lets HDTVs display colors more accurately. It enables display with natural, vivid colors. “x.v.Color” is a Sony registered trademark.

**Z****ZONE2**

This unit can operate in a room other than the room where this unit is placed (MAIN ZONE) (ZONE2 playback). The room for ZONE2 playback is called ZONE2.

# Troubleshooting

If a problem should arise, first check the following:

**1. Are the connections correct?**

**2. Is the set being operated as described in the owner's manual?**

**3. Are the other components operating properly?**

If this unit does not operate properly, check the items listed in the table below. Should the problem persist, there may be a malfunction.

In this case, disconnect the power immediately and contact your store of purchase.

## [General]

Symptom	Cause/Solution	Page
Power does not turn on.	<ul style="list-style-type: none"> <li>Check whether the power plug is correctly inserted into the power outlet.</li> <li>The protection circuit is active. Disconnect the power plug from the electric outlet, wait 5 to 10 seconds and then insert it back into the outlet.</li> </ul>	5 5, 75
Display is off.	<ul style="list-style-type: none"> <li>Set "Display" on the menu to something other than "OFF".</li> </ul>	58
The power indicator is blinking red in intervals of approximately 2 seconds.	<ul style="list-style-type: none"> <li>The temperature inside the unit has risen. Please turn off power once, and re-apply the power after the temperature has fallen sufficiently.</li> <li>Please re-install this unit in a place having good ventilation.</li> </ul>	– –
The power indicator is blinking red in intervals of approximately 0.5 seconds.	<ul style="list-style-type: none"> <li>Please use speakers which have the specified impedance.</li> <li>The speaker cable has shorted (is touching). Firmly twist the core wire in the speaker cable, and then re-connect it to the speaker terminal.</li> </ul>	4 4
After turning on the power, the power indicator is blinking red in intervals of approximately 0.5 seconds.	<ul style="list-style-type: none"> <li>This unit amplifier circuit has failed. Turn off the power and please contact the DENON service adviser.</li> </ul>	–
Set does not operate properly.	<ul style="list-style-type: none"> <li>Reset the microprocessor.</li> </ul>	78

## [Video]

Symptom	Cause/Solution	Page
No picture appears.	<ul style="list-style-type: none"> <li>Check the TV connection.</li> <li>Set the TV input correctly.</li> </ul>	5 6

## [Audio]

Symptom	Cause/Solution	Page
Audio is not output.	<ul style="list-style-type: none"> <li>Check the connections for all devices.</li> <li>Check the speaker connections.</li> <li>Check whether the audio device power is turned on.</li> <li>Adjust the master volume.</li> <li>Cancel the mute mode.</li> <li>Select a suitable input source.</li> <li>Select a suitable input mode.</li> <li>Disconnect the headphones. No sound is output from the speakers or the PRE OUT connectors when headphones are connected.</li> </ul>	5, 15 – 19 5, 31, 32 6 20, 37 20, 37 20, 37 46 65
No sound is produced from surround speaker.	<ul style="list-style-type: none"> <li>Check if the surround speakers are connected to the SURROUND terminals.</li> </ul>	–
No sound is produced from surround back speaker.	<ul style="list-style-type: none"> <li>Set "Amp Assign" on the menu to "Normal".</li> <li>Set "Speaker Config." – "S.Back" on the menu to something other than "None".</li> <li>Set "Surround Parameter" – "S.Back" on the menu to something other than "OFF".</li> <li>Set the surround mode to something other than "STEREO".</li> </ul>	52 53 48 26
No sound is produced from front height speaker.	<ul style="list-style-type: none"> <li>Set "Surround Parameter" – "Front Height" on the menu to "ON".</li> <li>Set "Amp Assign" on the menu to "Front Height".</li> <li>Set "Speaker Config." – "Surround" on the menu to something other than "OFF".</li> </ul>	48 52 –
No sound is produced from subwoofer.	<ul style="list-style-type: none"> <li>Check the subwoofer connections.</li> <li>Turn on the subwoofer's power.</li> <li>Set "Speaker Config." – "Subwoofer" on the menu to "Yes".</li> <li>If "Front" and "Center" for "Speaker Config." are set to "Large", and "Subwoofer Mode" is set to "LFE", no sound may be output from the subwoofers, depending on the input signal or selected surround mode.</li> </ul>	5, 31, 32 6 52 53
DTS sound is not output.	<ul style="list-style-type: none"> <li>Set "Decode Mode" on the menu to "Auto" or "DTS".</li> </ul>	46
Dolby TrueHD, DTS-HD, Dolby Digital Plus audio is not output.	<ul style="list-style-type: none"> <li>Make HDMI connections.</li> </ul>	14

**[HDMI]**

Symptom	Cause/Solution	Page
No audio is output with HDMI connection.	• Check the connection of the HDMI connectors.	14
	• When outputting HDMI audio from the speakers, set "HDMI Audio Out" on the menu to "Amp".	55
	• When outputting HDMI audio from a TV, set "HDMI Audio Out" on the menu to "TV".	55
No video is output with HDMI connection.	• Check the connection of the HDMI connectors.	14
	• Set the input source to match the connected HDMI connector.	14, 20
	• Check whether the TV is compatible with copyright protection (HDCP). If connected to a device not compatible with HDCP, video will not be output correctly.	14
When the following operations are performed on devices compatible with HDMI control, the same operations occur on this unit. • Power ON/OFF • Switching audio output devices • Adjust volume • Switch input source	• Set "HDMI Control" on the menu to "OFF". To operate power only for each device, set "Power Off Control" to "OFF".	34, 55

**[Radio]**

Symptom	Cause/Solution	Page
Reception fails, or there is a lot of noise or distortion.	• Change the antenna orientation or position.	19
	• Separate the AM loop antenna from the unit.	19
	• Use an FM outdoor antenna.	19
	• Separate the antenna from other connection cables.	19

**[iPod]**

Symptom	Cause/Solution	Page
iPod cannot be played.	• Check the iPod connections.	18
	• Plug the control dock for iPod's AC adapter into a power outlet.	-
	• Switch the input source to "DOCK".	20
	• If using an iPod connected to the USB port, incompatible iPod types cannot be played back.	22
"Connection Error" is displayed.	• Unable to communicate properly. Turn off the power to this unit, disconnect the iPod and then reconnect it.	-
"Not Support" is displayed.	• The iPod connected to the unit is not compatible. Please make sure the iPod you are connecting is compatible.	22
	• The software version of the connected iPod is an old one. Please update to the latest version.	-
"Connection Error" is displayed.	• The iPod is not responding. Turn off the power to this unit, disconnect the iPod and then reconnect it.	-

**[USB memory device]**

Symptom	Cause/Solution	Page
When a USB memory device is connected, "USB" is not displayed on the menu.	• The set cannot recognize a USB memory device. Check the connection.	18
	• A USB memory device not conforming to mass storage class is connected. Connect a USB memory device conforming to mass storage class.	-
	• A USB memory device cannot be connected via a USB hub.	18
Files on a USB memory device cannot be played.	• Set the USB memory device format to "FAT16" or "FAT32". For details, refer to the USB memory device's operating instructions.	-
	• If the USB memory device is divided into multiple partitions, only files stored in the top partition can be played.	-
	• The file is recorded in an incompatible format. Please record it in a compatible format.	-
	• This unit cannot play back files covered by copyright protection.	-
The file names are not displayed properly ("...", etc.).	• Characters that cannot be displayed on this unit are replaced by "." (period).	21, 23
The sound quality is poor or there is noise during playback.	• The file being played back has a low bit rate.	-
"Connection Error" is displayed.	• Unable to communicate properly. Turn off the power to this unit, unplug the USB memory device and then plug it back in.	-
	• The USB memory device is not responding. Turn off the power to this unit, unplug the USB memory device and then plug it back in.	-
"Overcurrent" is displayed.	• The USB memory device is consuming too much power. When using a USB portable hard disk that can be powered by an AC adapter, connect its AC adapter.	-

**[Remote control unit]**

Symptom	Cause/Solution	Page
The set cannot be operated with the remote control unit.	• Batteries are worn out. Replace with new batteries.	68
	• Operate the remote control unit within a distance of about 23 ft / 7 m from this unit and at an angle of within 30°.	68
	• Remove any obstacle between this unit and the remote control unit.	68
	• Insert the batteries in the proper direction, checking the ⊕ and ⊖ marks.	68
	• The set's remote control sensor is exposed to strong light (direct sunlight, inverter type fluorescent bulb light, etc.). Move the set to a place in which the remote control sensor will not be exposed to strong light.	68



## Resetting the microprocessor

Perform this procedure if the display is abnormal or if operations cannot be performed.  
When the microprocessor is reset, all the settings are reset to their default values.

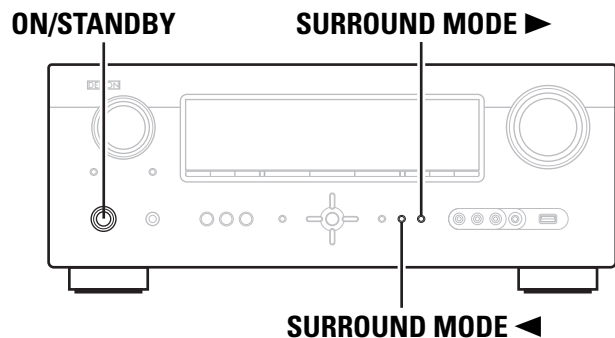

**1** Turn off the power using **ON/STANDBY**.

**2** Press **ON/STANDBY** while simultaneously pressing **SURROUND MODE** ◀ and **SURROUND MODE** ▶.

**3** Once the display starts flashing at intervals of about 1 second, release the two buttons.



If in step 3 the display does not flash at intervals of about 1 second, start over from step 1.

## Specifications

### Audio section

- Power amplifier  
Rated output:

Front:  
90 W + 90 W (8 Ω, 20 Hz – 20 kHz with 0.08 % T.H.D.)  
125 W + 125 W (6 Ω, 1 kHz with 0.7 % T.H.D.)

Center:  
90 W (8 Ω, 20 Hz – 20 kHz with 0.08 % T.H.D.)  
125 W (6 Ω, 1 kHz with 0.7 % T.H.D.)

Surround:  
90 W + 90 W (8 Ω, 20 Hz – 20 kHz with 0.08 % T.H.D.)  
125 W + 125 W (6 Ω, 1 kHz with 0.7 % T.H.D.)

Surround back:  
90 W + 90 W (8 Ω, 20 Hz – 20 kHz with 0.08 % T.H.D.)  
125 W + 125 W (6 Ω, 1 kHz with 0.7 % T.H.D.)  
6 – 16 Ω

#### Output connectors:

- Analog

Input sensitivity/Input impedance:

200 mV/47 kΩ

Frequency response:

10 Hz – 100 kHz — +1, –3 dB (DIRECT mode)

S/N:

100 dB (IHF-A weighted, DIRECT mode)

### Video section

- Standard video connectors

Input/output level and impedance:

1 V<sub>p-p</sub>, 75 Ω

Frequency response:

5 Hz – 10 MHz — +1, –3 dB

- Color component video connector

Input/output level and impedance:

Y (brightness) signal — 1 V<sub>p-p</sub>, 75 Ω

P<sub>B</sub> / C<sub>B</sub> signal — 0.7 V<sub>p-p</sub>, 75 Ω

P<sub>R</sub> / C<sub>R</sub> signal — 0.7 V<sub>p-p</sub>, 75 Ω

Frequency response:

5 Hz – 60 MHz — +0, –3 dB

### Tuner section

[FM]

[AM]

(Note: μV at 75 Ω, 0 dBf = 1 × 10<sup>-15</sup> W)

Receiving Range:

87.5 MHz – 107.9 MHz

520 kHz – 1710 kHz

Usable Sensitivity:

1.2 μV (12.8 dBf)

18 μV

50 dB Quietening Sensitivity:

MONO 2.8 μV (20.2 dBf)

S/N (IHF-A):

MONO 70 dB

STEREO 67 dB

Total harmonic Distortion (at 1 kHz):

MONO 0.7 %

STEREO 1.0 %

### General

Power supply:

AC 120 V, 60 Hz

Power consumption:

460 W

0.1 W (Standby)

3 W (CEC standby)

Maximum external dimensions:

434 (W) × 171 (H) × 381 (D) mm (17-3/32" × 6-47/64" × 15")

Weight:

10.2 kg (22 lbs 7.8 oz)

### Remote Control Unit (RC-1146)

Batteries:

R6/AA Type (two batteries)

Maximum external dimensions:

53 (W) × 224 (H) × 28 (D) mm (2-3/32" × 8-13/16" × 1-7/64")

Weight:

160 g (5.6 oz, including batteries)

For purposes of improvement, specifications and design are subject to change without notice.

## Index

 Numerics

2.1-channel	32
2ch DIRECT/STEREO	55
3D	14
5.1-channel	4
6.1-channel	30, 31
7.1-channel	30, 31

 A

Accessories	1
Adjust CH	51
Adobe RGB color / Adobe YCC601 color	74
AFDM	48
AM loop antenna	19
Amp Assign	52
ARC	15
Aspect	45
Audio Adjust	47
Audio cable	5, 16, 17, 19
Audio Delay	51
Audio Setup	55
Audyssey Auto Setup	6, 33
Audyssey Dynamic EQ	50, 74
Audyssey Dynamic Volume	50, 74
Audyssey MultEQ	49, 65, 74
Audyssey Settings	49
Auto Lip Sync	55, 74
Auto Preset	43
Auto Setup	6, 33
Auto Surround Mode	56

 B

Banana plug	4
Base Curve Copy	51
Bass	49
Bass Setting	53
Bi-amp	32
Browse mode	21, 23

 C

Cable	
Audio cable	5, 16, 17, 19
Coaxial digital cable	17
Component video cable	17
HDMI cable	5, 15
Optical cable	16
Speaker cable	5
Video cable	16, 17
Center Image	47
Center Width	48

Channel Level	54
Characters	41
Cinema EQ	47
Coaxial digital cable	17
Component video cable	17
Condensation	2
Connection	
Antenna	19
Blu-ray Disc player	15, 16
Cable TV	17
CD player	19
Control dock for iPod	18
Digital camcorder	17
DVD player	15, 16
Game console	15
HDMI	14
iPod (USB)	18
Power cord	5
Satellite tuner	17
Set-top box	15, 17
Speaker	4, 31
TV	5, 15, 16
USB memory device	18
Crossover Frequency	54

 D

D.Comp	47
Decode Mode	46
Deep Color	14, 74
DENON original surround mode	28
Dimension	48
Display	58, 65
Distance	53
Dolby	
Dolby Digital	27, 74
Dolby Digital EX	27, 74
Dolby Digital Plus	27, 74
Dolby Pro Logic II	74
Dolby Pro Logic IIx	74
Dolby Pro Logic IIz	30, 74
Dolby TrueHD	27, 74
Downmix	74
DRC	47
DTS	27, 74
DTS 96/24	27, 74
DTS-ES Discrete 6.1	27, 74
DTS-ES Matrix 6.1	27, 74
DTS-HD	27, 74
DTS-HD High Resolution Audio	74
DTS-HD Master Audio	74
DTS Digital Surround	74
DTS Express	74
DTS NEO:6™ Surround	26, 75

Dynamic EQ	50
Dynamic range	75
Dynamic Volume	50

 E

Effect Lev.	48
EQ Customize	56
Error messages (Auto Setup)	10

 F

FM indoor antenna	19
Front A/B (connection)	30, 32
Front Height	48, 53
Front height speaker	30, 31
Front Panel	65
Front Speaker Setup	54

 H

HDCP	14, 75
HDMI	14, 75
HDMI 1.4	14, 15
HDMI Audio Out	55
HDMI cable	5, 15
HDMI Control	34, 55
HDMI Setup	55
Headphones	65
Height Gain	49

 I

Information	59
Audio Input Signal	59
Auto Surround Mode	59
HDMI Information	59
Preset Channel	59
Quick Select	59
Status	59
Input Assign	44
Input Mode	46
Input Setup	42
Input signal	27, 72
iPod PLAY	23
i/p Scaler	45

 L

Level Lch	56
Level Rch	56
LFE	47, 75
Listening mode	26
Listening position	7

 M

MAIN ZONE	37, 75
-----------	--------

Manual EQ	51
Manual Setup	52
Master volume display	57
Menu map	39
Mode	47
MP3	75
MPEG	75
MultEQ	49
Mute Level	56, 57

 O

On-Screen Display	57
Optical cable	16
Option Setup	57
Display	58
On-Screen Display	57
Quick Select Name	57
Remote Preset Codes	57
Setup Lock	58
Source Delete	57
Volume Control	57
Zone Rename	58

 P

Panorama	48
Parameter Check	10
Playback	
Blu-ray Disc player	21
CD player	21
Direct	28
DVD player	21
FM/AM broadcasts	24
iPod (Control dock for iPod)	21
iPod (USB)	22
MP3	25
Pure direct	28
Standard	26
Stereo	28
USB memory device	25
WMA	25
ZONE2	37
Playback Mode (Control dock for iPod)	46
Playback Mode (USB)	46
Power Off Control	55
Power On Level	56, 57
Preset codes	57, 60
Preset Name	44
Preset Skip	43
Presetting radio stations	24
Progressive	75
Progressive Mode	45
Protection circuit	75

 **Q**

Quick select ..... 36, 38  
 Quick Select Name ..... 57

 **R**

Rear panel ..... 66  
 Reference Level Offset ..... 50  
 Remote control unit ..... 60, 67  
     Inserting the batteries ..... 68  
     Operating components ..... 62  
     Registering Preset Codes ..... 60  
 Remote mode ..... 21, 23  
 Remote Preset Codes ..... 57  
 Rename ..... 46  
 Repeat ..... 46  
 Resetting the microprocessor ..... 78  
 Resolution ..... 45  
 RESTORER ..... 51  
 Room Size ..... 48

 **S**

Sampling frequency ..... 75  
 S.Back ..... 48, 53  
 Screensaver ..... 57  
 Selecting the input source ..... 20  
 Setup Lock ..... 58  
 Shuffle ..... 46  
 Sleep timer ..... 35  
 Source Delete ..... 57  
 Source Level ..... 46  
 S/PDIF ..... 75  
 Speaker  
     Connect ..... 4, 31  
     Install ..... 4, 30  
     Set up ..... 6, 33  
 Speaker cable ..... 5  
 Speaker Config. .... 52  
 Speaker impedance ..... 4, 75  
 Speaker Setup ..... 52  
 Standby Source ..... 55  
 Subwoofer ..... 49  
 Subwoofer setting ..... 7  
 Surround back speaker ..... 30, 31  
 Surround Mode ..... 26, 70  
 Surround Parameter ..... 47  
 sYCC601 color ..... 75

 **T**

Tone ..... 49  
 Tone Control ..... 49  
 Trademark ..... 69

Treble ..... 49  
 Turn off power (standby) ..... 11  
 Turn on power ..... 6

 **V**

Video ..... 45  
 Video cable ..... 16, 17  
 Video conversion ..... 13  
 Video Mode ..... 45  
 Video Select ..... 45  
 Volume Control ..... 57  
 Volume Limit ..... 56, 57

 **W**

WMA ..... 75

 **X**

x.v.Color ..... 75

 **Z**

ZONE2 ..... 37, 65, 75  
 ZONE2 Setup ..... 56  
 Zone Rename ..... 58

**DENON**

[www.denon.com](http://www.denon.com)

D&M Holdings Inc.  
Printed in China 5411 10418 009D